



ZF400GS-C

Two-Wheel Motorcycle Instruction Manual

KOVE RACING

On the world stage since 2023

SBLK SUPERSPORT300
FIM WORLD CHAMPIONSHIP



RALLYE DU
MAROC
THE ESSENCE
OF RALLY RAID



From road racing to rally raids—
facing the fastest, forging history.

SBK SUPERSPORT300
FIM WORLD CHAMPIONSHIP

WorldSBK

The world's premier production-motorcycle racing series.



October 19, 2025

KOVE 350RR claimed the WSBK-SSP300
World Championship title.



The 2025 season marked the final year of the SSP300 class. The category will be replaced by the SportBike class

Since entering the WSBK in 2023, KOVE secured the SSP300 overall championship in just three seasons, along with 4 race wins, 6 runner-up finishes, and 5 third-place finishes.

DAKAR RALLY

– The world's toughest rally raid

2023 Season

Three KOVE 450 RALLY bikes entered the race, and KOVE became the first manufacturer worldwide to finish Dakar with every bike on its debut.



2024 Season

With the newly developed in-house engine, the 450 RALLY EX achieved P3 in SS1 and P5 in SS5.

2025 Season

KOVE factory team secured P15 overall, reshaping global perceptions of Chinese motorcycle performance, attracting an increasing number of professional riders to choose KOVE.

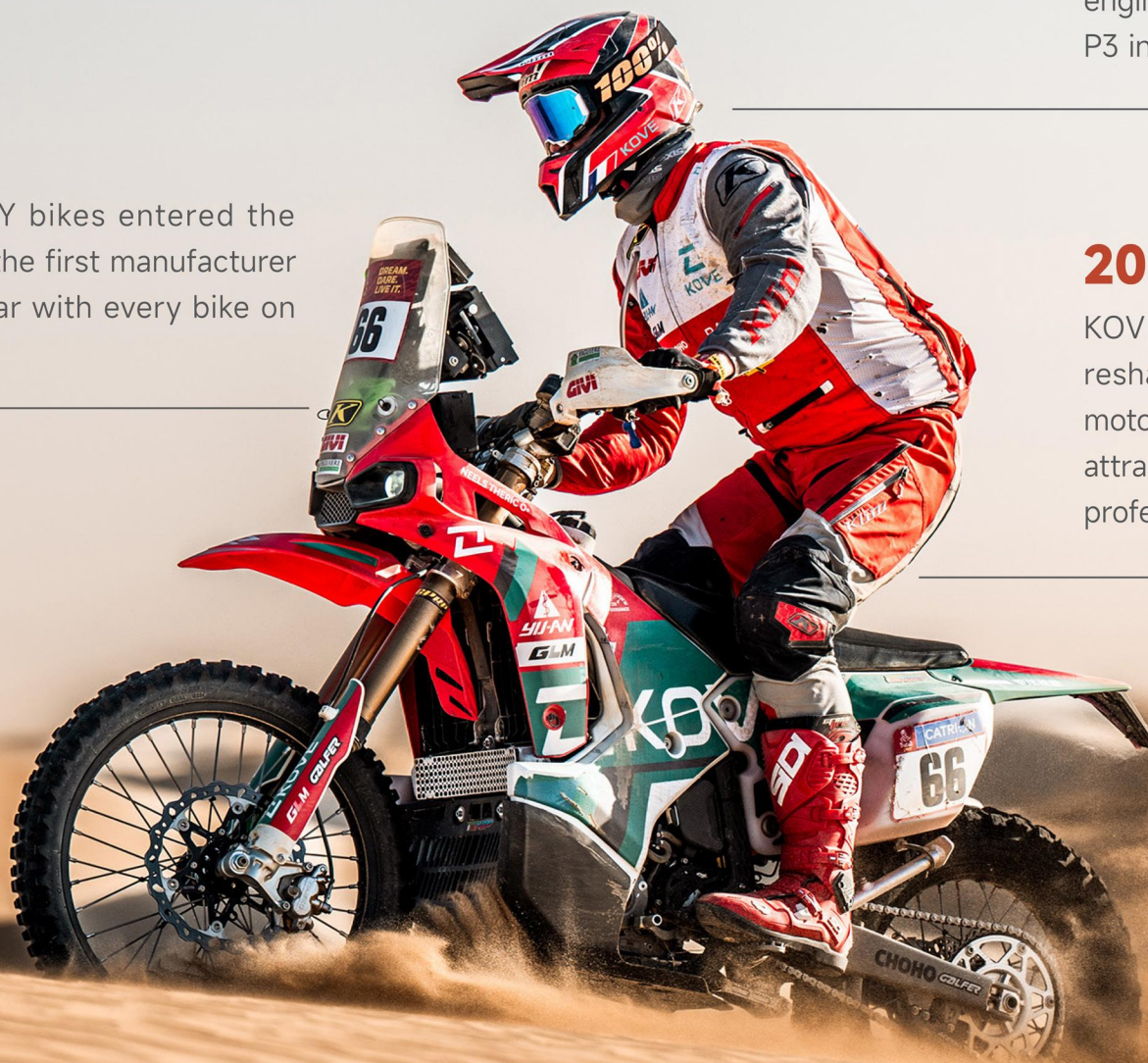



Racing Fuels Production

Beyond WSBK and Dakar, KOVE continues to raise the bar across the Rallye du Maroc, the BAJA World Cup, and the BSB Championship—showing the strength of Chinese engineering on the global stage.

If racing cannot shape the product, it loses its meaning. Results are only a by-product; the goal is always to serve the rider.

Breaking technical barriers through competition.

Advancing product performance through real racing.

To Our Distinguished Owner

ZF400GS-C International Version/Euro 5+ Two-Wheel Motorcycle Instruction Manual

First Edition (November 2025)

First of all, congratulations on your purchase of a brand new KOVEMOTO!

If you choose products of KOVEMOTO, you will become a member of the KOVEMOTO family.

This Instruction Manual introduces the main specifications, basic structure, adjustment method and maintenance knowledge of the motorcycle. It will guide you to master the basic operation of the motorcycle and eliminate or reduce common faults, which can effectively ensure driving safety, play the best performance of the vehicle, and improve the service life of the vehicle.

This Instruction Manual contains the introduction of the basic configuration of the motorcycle. The contents and pictures are for reference only, please refer to the physical object.

Due to the production time, user needs and design improvements, the actual motorcycle may be different from the contents of the Manual. We reserve the right to make changes at any time, and we will no longer notify and assume any obligations. Sorry for any inconvenience caused.

The Instruction Manual is one of the necessary accessories of the motorcycle, and when it is sold to others, it should be attached to the motorcycle.

The copyright of this Instruction Manual belongs to the company, and no reproduction is allowed without the written consent of the company, and violators will be prosecuted.

To ensure your safety, and increase your riding pleasure:

- Please read the Instruction Manual carefully.
- Please follow all recommendations and procedures in the Instruction Manual.
- Please pay close attention to the safety information recorded in the Instruction Manual and pasted on the motorcycle body.

Safety Precautions

The safety of you and others is very important, and the safe driving of this motorcycle is an important responsibility.

To help you make an informed decision about your safety, we provide steps and other information on the safety label and in the Instruction Manual to remind you. This information is intended to alert you to the potential danger of harm to you or others.

It is impractical for us to list all the hazards associated with motorcycle riding and maintenance, and you must make the right judgment yourself.

It is prohibited to install additional electrical appliances, as this may result in battery drain.

The motorcycle is equipped with a high-speed engine. For your driving safety, it is recommended that you reduce violent driving.

You'll see important security information in a variety of forms, including:

- Safety labels on the body of a motorcycle;
- The safety information is preceded by a safety warning symbol  and one of the following three warnings : Caution, danger, and warning.

 Caution - If you do not follow the instructions, you may be injured.

 Danger - If you do not follow the instructions, you will cause significant casualties.

 Warning - If you do not follow the instructions, you will cause serious casualties.

Other important information is listed under the following headings:

Notes - Information to help you avoid damage to your motorcycle, other property, or the environment.

Contents

Motorcycle Safety4

User Manual13

Maintenance30

Fault Handling63

Relevant Information73

Technical Parameters83

Motorcycle Safety

This section contains important information about the safe riding of motorcycles, please read this section carefully.

Safety Instructions	5
Safety Precautions	8
Riding Precautions.....	9
Spare Parts and Modifications	12
Loading Guide	12

Safety Instructions

To enhance your driving safety, please follow these guidelines:

- Perform all routine and routine inspections as specified in the Instruction Manual.
- Before filling the tank, turn off the engine and keep away from sparks and open flames.
- Do not start the engine for a long time in a closed or semi-closed space, because the exhaust gas contains carbon monoxide, which is a toxic gas and can be fatal.

Always wear a helmet

It has been proven that helmets and protective clothing can significantly reduce the chance of injury to the head and other parts, and reduce the degree of injury. Therefore, please be sure to wear a certified motorcycle helmet and protective clothing when driving.

Before the ride

Make sure you're in good physical condition, paying attention, and not drinking or taking medication. Make sure that you and your passengers are wearing a certified motorcycle helmet and protective clothing. Make sure your passenger to hold onto the rear grab handle or hold your waist, place his/her feet on the pedals, and lean with you when you turn, even when the motorcycle is stopped.

Take time to study and practice

Even if you have driven other motorcycles, you should practice riding this motorcycle in a safe area to familiarize yourself with the operation and operation of this motorcycle and adapt to the size and weight of the motorcycle.

Have a sense of protection when riding

Always pay attention to the vehicles around you, do not think that other drivers can see you, always be prepared to make emergency brakes or avoid detours.

Make yourself easier to see

Especially at night, wear bright reflective clothing to make yourself more eye-catching, stop so that other drivers can see you, turn on the signal light before turning or changing the lane, and when necessary, use the horn to remind pedestrians.

Don't drink and ride

Alcohol and driving are not compatible. Never exceed your personal ability when driving, and do not exceed the speed specified by the vehicle, fatigue and negligence will weaken your ability to make correct judgments and safe driving.

Keep your motorcycle in a safe state

It is important to take good care of your motorcycle so that your motorcycle is always in good condition. Check your motorcycle before each ride and complete all recommended maintenance and repairs. **Do not modify motorcycles or add accessories that will affect safety without authorization, and overload is strictly prohibited.**

Dealing with incidents

Your personal safety is your first priority. If you or anyone else is injured, you should first carefully evaluate the severity of the injury and determine whether it is safe to continue driving, and call for emergency assistance if necessary. If other persons or vehicles are involved in a collision, the applicable local laws and regulations should also be followed.

If you decide to continue driving, first turn the ignition switch to the “” (OFF) position, and then evaluate the condition of the motorcycle. Check whether there is oil leakage, check whether the key nuts and bolts are fastened, and check the steering handle, steering column, brake and wheel to ensure that the personnel and vehicle are safe. Please drive slowly and carefully. Your motorcycle may have suffered damage that will not be immediately apparent, please submit it to an authorized KOVE-MOTO motorcycle service center or a qualified special repair shop for a thorough inspection as soon as possible.

Carbon monoxide hazard

The exhaust gas contains toxic carbon monoxide, a colorless and odorless gas, and inhaling higher concentrations of carbon monoxide can cause people to lose consciousness and may even be fatal.

Do not start the engine for long periods of time in a garage or other enclosed space.

▲ Warning

- If the engine is started for a long time in a closed or semi-closed space, it may cause a rapid accumulation of toxic carbon monoxide gas.
- Inhaling this colorless, odorless gas causes rapid loss of consciousness and death.
- Motorcycle engines should only be started in well ventilated outdoor areas.

Safety Precautions

- Be careful when riding, always keep your hands on the throttle grips and your feet on the pedals.
- Make sure that the passenger grasps the grab handle or hugs your waist while driving, and puts his/her feet on the pedals.
- Always pay attention to the safety of riders, passengers and other drivers on the road.

Protective clothing

Make sure that you and any accompanying passenger are wearing a certified motorcycle helmet, goggles and eye-catching protective clothing, and drive carefully according to the weather and road conditions.

■ Helmet

It is certified to safety standards, eye-catching, and sized to fit your head size.

- It must be safe and comfortable and secured with a chin strap.
- It does not obstruct the line of sight of the mask or other certified goggles.

■ Gloves

High-wear-resistant full-finger leather gloves.

■ Boots or riding shoes

Boots that are strong and slip-resistant and protect the ankle.

■ Clothing

It includes a protective eye-catching long-sleeved shirt suitable for riding and wear-resistant pants (or protective suits).

▲ Warning

- Not wearing a helmet increases the chance of serious injury in an accident.
- Make sure that you and your passengers always wear certified helmets and protective clothing.

Riding Precautions

Run-in period

Follow these guidelines during the first 1000 km of driving to ensure the motorcycle's later reliability and performance.

- Avoid full throttle start or rapid acceleration.
- Avoid emergency braking and rapid downshifting.
- Ride carefully.

Brake

Follow the following guidelines:

- Avoid excessive emergency braking and downshifting
 - ▶ Sudden braking will reduce the stability of the motorcycle.
 - ▶ Slow down before turning, or you may slip.
- Be careful when driving on slippery roads
 - ▶ Tyres are easier to slide on slippery surfaces and require longer braking distances.
- Avoid continuous braking
 - ▶ In the long and steep slope down the slope, repeated braking will lead to serious overheating of the brake, affecting the braking effect. You should use the engine brake and use the brake intermittently to slow down.
- The front and rear brakes can be used at the same time to achieve a complete braking effect.

■ Anti-lock brake system (ABS)

This model is equipped with an anti-lock braking system to prevent tire lock-up during emergency braking.

- When the vehicle speed is less than 5 km/h, the anti-lock braking system does not work.
- During braking, after ABS intervention, the brake handle or Foot brake lever may slightly rebound, which is a normal phenomenon.
- Always use the recommended tyres to ensure that the anti-lock braking system works correctly.

■ Engine brake

When you release the accelerator, the engine braking will help the motorcycle slow down. If you want to slow down further, you can downshift to a lower gear. When going downhill on a long and steep slope, you should use engine braking and apply the brakes intermittently to slow down.

■ A humid and rainy environment

In a wet and rainy environment, the road surface will be wet and slippery, and the wet brake will also reduce the braking efficiency. You need to be very careful when braking. If the brake is wet, it can be intermittently repeated during low-speed driving and riding, which helps to dry the brake quickly.

Parking

- Stay on solid, flat ground.
- If you must stop on a slightly inclined or loose ground, make sure to stop the motorcycle and make sure that the motorcycle cannot move or tip over.
- Ensure that high temperature parts do not come into contact with flammable materials.
- Do not touch the engine, muffler, brake and other high temperature parts before cooling.
- To avoid the possibility of theft, be sure to lock the steering handle and remove the key before leaving the unattended motorcycle.

Stop the motorcycle with the side support

1. Extinguish engine.
2. Lower side support.
3. Tilt the motorcycle slowly to the left until its weight is concentrated on the side bracket.
4. Turn the steering handle completely to the left.
 - ▶ If the steering handle is turned to the right, it will reduce stability and may cause the motorcycle to fall.
5. Turn the ignition switch to the “” (lock) position and remove the key.

Fueling/brake fluid and fuel guide

Follow these guidelines to protect your engine and catalytic converter:

- Use only unleaded gasoline.
- It is recommended to use high octane gasoline. The use of low octane gasoline will reduce the performance of the engine.
- It is not recommended to use ethanol gasoline, which will reduce the performance of the engine.
- Do not use spoiled or contaminated gasoline, or oil-gasoline blends.
- Prevent dirt and water from entering the tank.
- Since the brake fluid has a certain corrosive effect, be sure to avoid splashing into the eyes, adhering to the skin and avoiding contact with nonmetallic materials of the vehicle when adding.

Spare Parts and Modifications

We strongly recommend that you do not use any accessories other than KOVEMOTO, and do not modify the original design of the motorcycle, which will cause the motorcycle to be unsafe. Unauthorized modifications to your motorcycle will void your warranty service and result in your motorcycle being unable to legally drive on public roads and highways. Before you decide to add accessories to your motorcycle, first determine which modifications are safe and legal.

It is prohibited to attach a trailer or a sidecar to a motorcycle and to modify or install other equipment at the engine installation point. Your motorcycle does not have the design of these accessories, and their use will seriously damage the maneuverability and safety of the motorcycle.

▲ Warning

- Improper accessories or modifications may cause safety accidents, in which you may be seriously injured or even life-threatening.
- Please follow all instructions in the Instruction Manual for accessories and modifications.

Loading Guide

- The additional load will affect the maneuverability, braking and stability of the motorcycle. When riding with heavy loads, be sure to maintain a safe speed.
- Please stay within the specified loading limit. The payload of the vehicle is 150kg. Do not overload it.
- Fix all luggage and place it evenly and smoothly near the center of the motorcycle.
- Do not place objects in the headlights or Mufflers.

▲ Warning

- Overloading or improper loading will lead to accidents, resulting in serious casualties.
- Please follow the loading instructions in the Instruction Manual.

User Manual

This section contains important information about the operation of the motorcycle, please read this section carefully.

Parts Location Diagram	14
Instruments	16
Handlebar Switch	22
Ignition Switch	24
Start The Engine	25
Gear Shifting.....	26
Quick Shift System	27
Traction Control Ystem	28
Refueling	29

Component Location Diagram

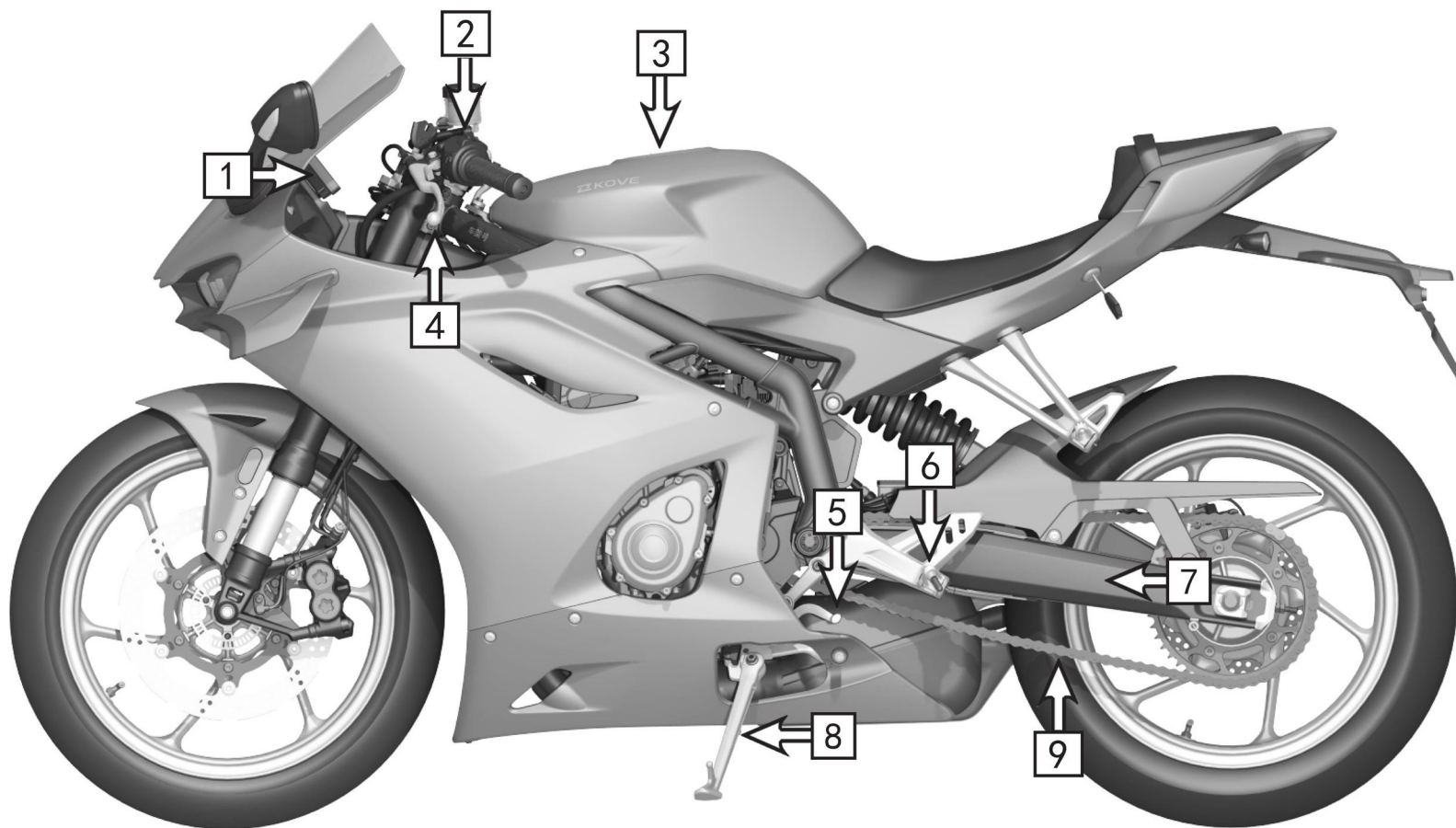

1.Instrument assembly 2.Handlebar switch-left 3.Fuel tank lock 4.Clutch lever 5.Shift pedal 6.Front footpeg assembly-left
7.Swingarm 8.Side stand 9.Chain

Component Location Diagram

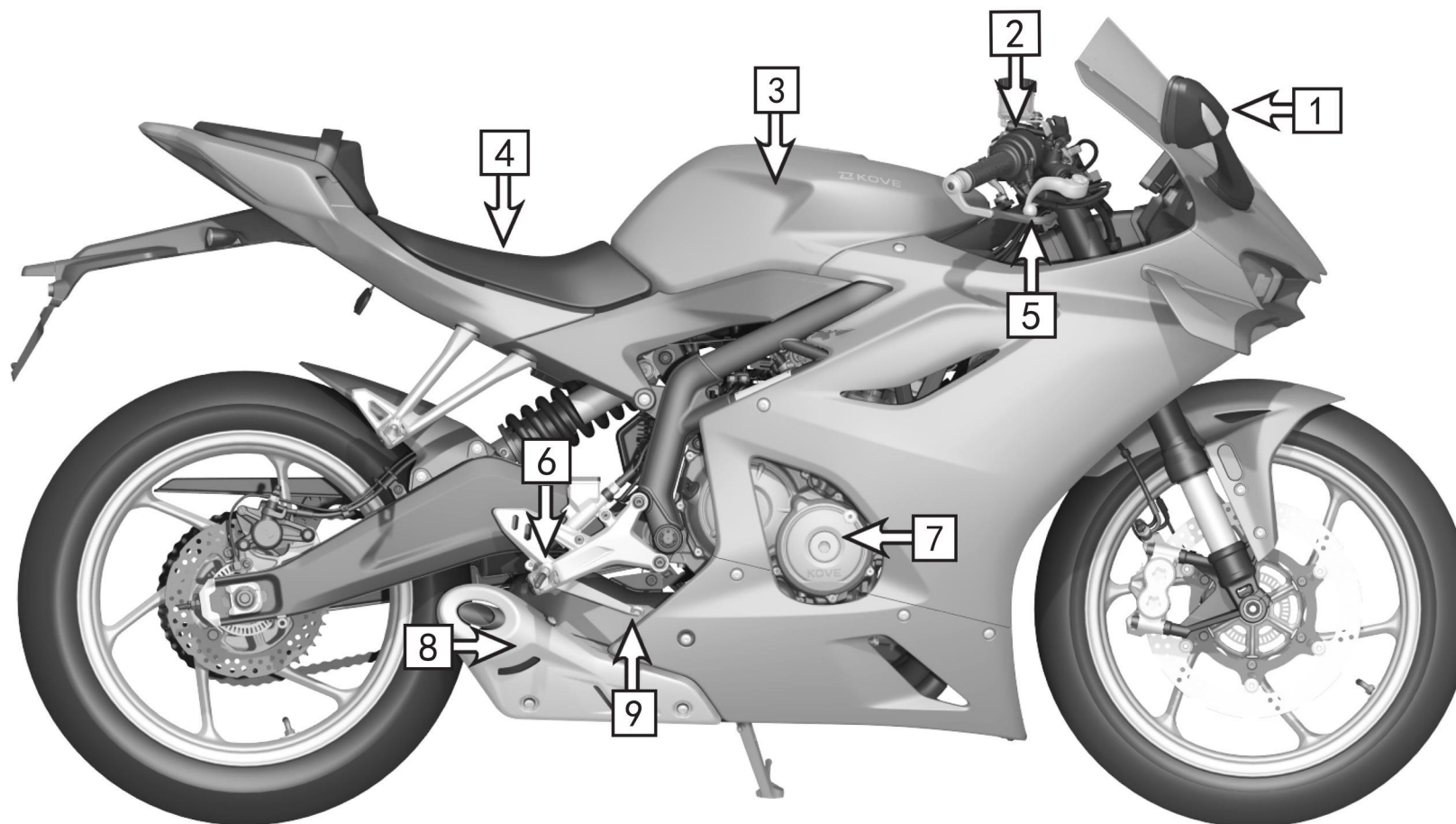

1.Rear view mirror 2.Handle switch-right 3.Fuel tank 4.Front seat cushion 5.Front brake lever 6.Front footpeg assembly - right 7.Engine 8.Muffler 9.Rear brake pedal

Instruments



Light-sensitive hole

Display check

When the ignition switch is turned to “” (ON), the instrument is powered on to play the start-up animation, and then self-test is performed, and all functional modules and symbols are displayed. If the display is missing during self-test, Please go to an authorized KOVEMOTO motorcycle service center for inspection or maintenance.

Instrument Interface Description -1

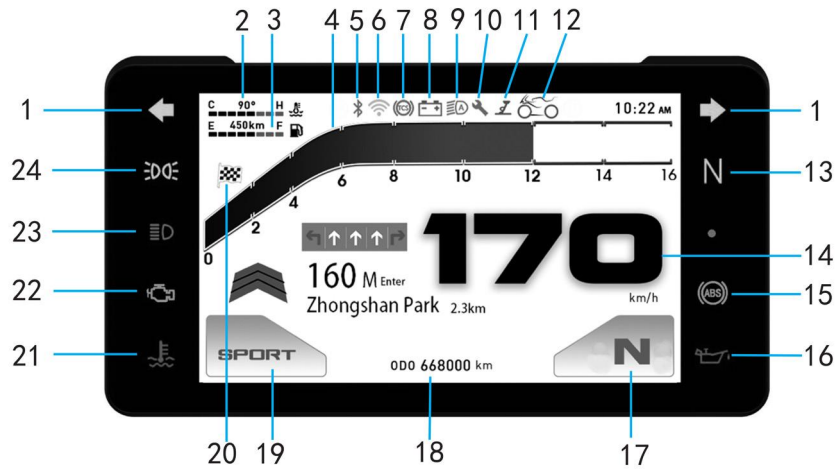

SN	Name	Functional Description
1	Turn indicator light	The left turn indicator flashes when the left turn signal is ON The right turn indicator flashes when the right turn signal is ON When the warning indicator is ON, the left and right turn indicators flash simultaneously
2	Water temperature display	① When the water temperature indicator block displays red and lights up the “water temperature alarm lamp”, it means that the water temperature is too high. In the case of ensuring safety, stop for inspection, and continue driving after the water temperature drops ② When the water temperature data is abnormal, all water temperature color blocks and icons will flash together (when the flameout switch is off, the flashing is a normal phenomenon)
3	Fuel display	Displays oil level of fuel ① When the oil level is below one bar, please replenish the fuel as soon as possible ② If the fuel symbol and oil level flash simultaneously, it indicates abnormal oil level signal. Please visit an authorized KOVEMOTO motorcycle service center for inspection as soon as possible ③ The driving range calculation result is affected by many factors such as vehicle operating conditions and ride habits. The display data is for reference only.

SN	Name	Functional Description
4	Tachometer	Engine speed display
5	Bluetooth display	When connected to a phone bluetooth, this light turns on.
6	Network indicator	When connected to WIFI, this light turns on
7	TCS Indicator	① When TCS function is deactivated: the indicator remains lit ② When TCS malfunctions: the indicator remains lit (it is normal for this indicator to stay on after the vehicle is powered on; when the vehicle speed exceeds 5 km/h, the indicator extinguishes once passing the self-test; ③ When TCS Intervenes: indicator flashes
8	Charging fault indicator	When the battery voltage is too low, this light remains lit; When the battery volt is too high, this light flashes;
9	Automatic headlights	When when the automatic headlight function is activated, this light turns on
10	Service indicator light	When the motorcycle reaches the maintenance setting condition, this lamp turns on
11	Side stand switch	When the side stand is down, this light turns on
12	ABS status display	① White outlines on both front and rear wheels: Standard Mode activated ② ABS status icon shows solid light blue: Performance Mode activated ③ Yellow flashes on both front and rear wheels: ABS disabled for both wheels
13	Neutral indicator	When in neutral, this light turns on
14	Speedometer	Display the current speed

Instrument Interface Description -2

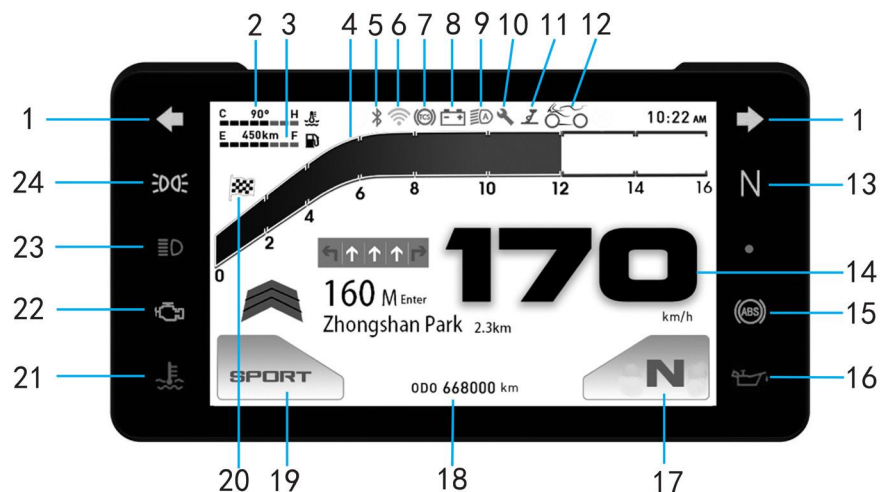

SN	Name	Functional Description
15	ABS malfunction indicator light	① This light turns on when a fault occurs ② After the whole vehicle is powered on, this lamp flashes as a normal phenomenon (0.5S on, 0.5S off). When the vehicle speed is > 5km/h, the ABS self-test is extinguished immediately after passing
16	Oil pressure indicator	When the oil pressure is insufficient, this light turns on
17	Gear indicator	Display the current gear
18	Odometer	Display vehicle total mileage
19	Riding mode	ECO is displayed in economy mode, SPORT is displayed in sport mode
20	Launch indicator	① Long press the launch control switch button, and the indicator light will begin flashing ② When the launch control function is ready, the indicator light remains lit
21	Water temperature indicator	When the water temperature is too high, this light turns on
22	Electronic injection malfunction indicator light	When the electronic fuel injection system fails, this light turns on (after the engine is powered on, the light illuminates. After the normal start, this malfunction indicator goes out as a normal phenomenon)
23	High beam indicator	When the high beam is switched on, this light turns on
24	Position indicator light	When the position light illuminates, this light turns on

Menu Instructions-1

Level 1 Menu	Level 2 Menu	Level 3 Menu	Description
Ride Data	Sub-total mileage	/	Vehicle data displays.
	Average fuel consumption	/	Note: 1. When the average vehicle speed = 0, the average vehicle speed displays "--"
	Avg. speed	/	2. The average fuel consumption result is affected by many factors such as vehicle operating conditions and ride habits. The display data is for reference only.
	Riding time	/	3. Long press the SET key to clear the current mileage information.
	Battery voltage	/	4. Real-time altitude display requires the installation of a relevant app and connection to a mobile phone to function.
	Real-time altitude	/	
Vehicle Settings	Riding mode	ECO	Set the engine power output mode (SPORT: sport mode, ECO: economy mode), and the riding mode has a memory function
		SPORT	
	ABS mode	Standard mode	Set the ABS working status, and the current ABS working status is displayed through the instrument icon
		Performance mode	
		ABS closed	
	TCS settings	Enable TCS	Set TCS working status
		Temporarily Off	
		Permanently Off	
	Headlight mode	Automatic headlights	After the engine starts, when this function is selected in "Headlight Mode," the headlight switch is automatically controlled based on ambient brightness
		The headlights are always on	After the engine starts, when this function is selected in "Headlight Mode", the headlight turns on
		Manual headlight	When this function is selected in "Headlight Mode," the headlights can be switched ON or OFF, and the system will automatically back off this mode afterward
	Maintenance setting	/	① Setting and clearing maintenance mileage or time: The first maintenance mileage is at 1,000km. This default parameter cannot be modified. After that, users can set the maintenance reminder cycle according to their actual needs ② Maintenance prompt clearing method: Long press ENT key under the maintenance service interface to pop up the clearing dialog box, and operate according to the prompt content

Menu Instructions-2

Level 1 menu	Level 2 menu	Level 3 menu	Description
Connection Settings	Bluetooth connection	/	Set the mobile phone for Bluetooth connection available (in order to ensure normal connection, the mobile phone-specific APP needs to enable relevant permissions according to the prompts)
	WiFi connection	/	Set the mobile phone for WIFI connection available (when WIFI is connected, do not choose to use the instrument WIFI to surf the Internet, otherwise it will affect the mobile phone surfing function)
	Reset	/	Reset connection settings
Alert Message	/	/	/
Display Settings	Display setting	Auto	Users can choose the day and night UI mode that has been used according to their preferences, and the factory default is automatic
		Night mode	
		Day mode	
	Brightness settings	Auto	Users can choose the screen brightness level that has been used according to their own preferences, and the factory default is automatic
		Level 1	
		Level 2	
		Level 3	
	Time settings	Auto settings	The user can set the time mode, which will automatically synchronize with the mobile phone's time when connected via Bluetooth
		24H/12H	
		Manual settings	
	Language settings	Chinese	Chinese/English menu switch
		English	
Unit settings	Metric	Metric/Imperial unit conversion	
	Imperial		
Equipment information	/	Instrument version number display	

The instrument functions are as follows:

Vehicle data viewing:

On the main interface of the instrument, you can press the SET button to flip through pages and view relevant vehicle data.

Information viewing:

When the mobile phone is connected with Bluetooth, the message display panel will reflect the information pushed by the mobile phone. Press the SET key to view the details, and press the BACK key to clear it.

Instrument navigation operation:

When Bluetooth/WIFI connection with the phone is normal and the dedicated APP on the phone has set up navigation, long press the Up button to enter full-screen navigation instrument, long press the Down button to enter simple navigation instrument, and press the BACK button to exit the navigation interface on the instrument.

Function setting:

Press the SET key to enter the instrument menu. You can set riding mode (SPORT or ECO), ABS mode, instrument brightness , riding data, headlight (on or off), time, language, and other parameters according to the human-machine dialogue menu.

Instrument and mobile phone interconnection:

1. The positioning function, navigation function, information push function, automatic time function, altitude display and other functions in the TFT instrument can only be realized after interconnection with the mobile phone installed with the relevant APP.
2. Steps to install the phone APP: ① Enter Instrument Settings; ② Select Connection Settings; ③ Use a phone connected to the internet to scan the “WIFI Connection” on interface, then download and install the APP as prompted; ④ Enable the phone bluetooth/WIFI to realise the interconnection with the instrument (for optimal user experience, please refer to the APP usage guide when using the phone APP).

Notes

- If you need to modify the ABS mode or TCS mode, it must be conduct while the vehicle is parked.

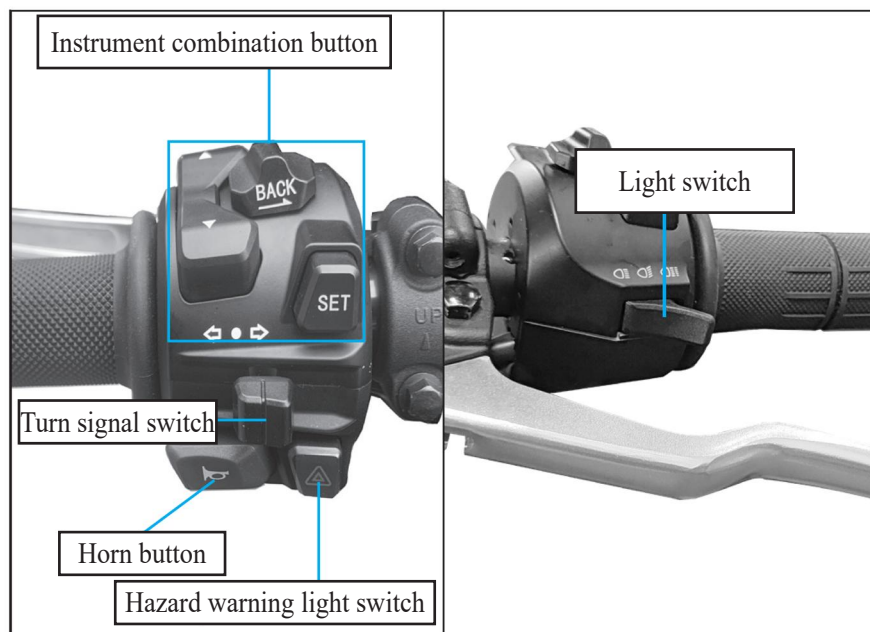

Handlebar Switch

Instrument Angle Adjustment



Light switch

The light switch is located on the back of the handlebar switch.

-  Turn on the headlight flasher
-  Turn on the high beam
-  Turn on the dipped beam

Menu switch:

This combination button is used to set different functions of the instrument.

  Toggle Up/Down

BACK: Return button

SET: Confirm button

Hazard warning light switch:

 Use in emergency situations. When pressed, it simultaneously activates the left and right turn signal.

Turn signal switch:

 Turn on the left turn signal: toggle the switch to the left, and the turn signal switch returns to its original position after operation.

 Turn on the right turn signal: toggle the switch to the right, and the turn signal switch returns to its original position after operation.

 Turn off the turn signal: When the turn signal switch is in the middle position, press this button to turn off the turn signal.

Right Combination Switch

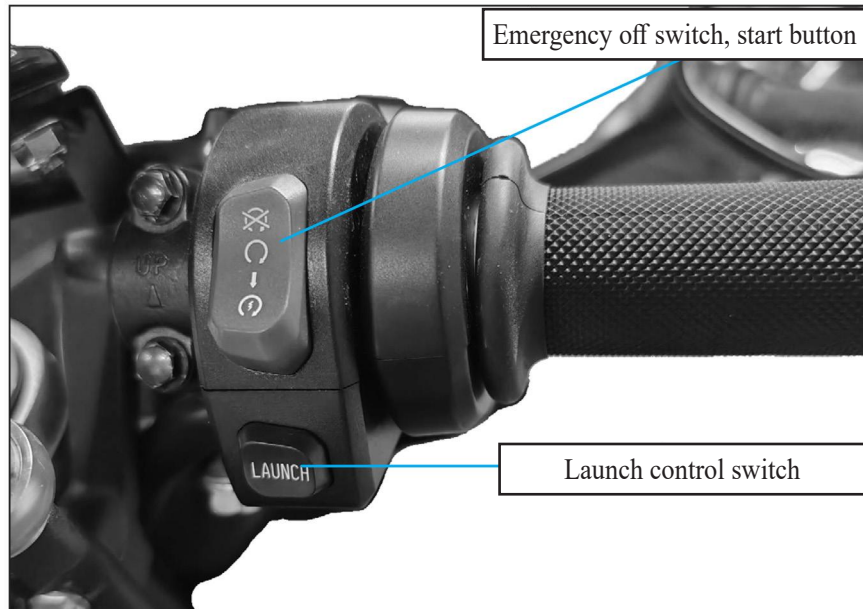

Emergency OFF switch:

Only when the switch is in “”(ON) position, the engine can be started.

When the switch is in “”(OFF) position, the engine cannot be started.

▶ In case of emergency, switch to the “” (stop) position to extinguish the engine.



Launch control switch:

When the launch function is activated, even with the throttle fully open, the engine speed is limited to 8000 rpm.

Hold the clutch lever, shift into 1st gear, and long press the launch control switch for 3 seconds. At this point, the launch control function will be activated with the indicator light flashing, and you can release the launch control switch. Fully twist the accelerator to ensure the indicator light remains lit, then release the clutch lever to complete the launch.

Electric starter button:



When the emergency OFF switch is set to “” position:

- ① If the engine is in neutral, press the “” button to start the engine.
- ② If the engine is not in neutral, pull handle, retract side stand, and press the “” button to start Engine.



Notes

- To extend the lifespan of the switch, it is recommended to use the compression air to blow out any accumulated water inside the switch after car washing or heavy rain.



Ignition Switch

When the key is in the “” position, turn the direction handle to the leftmost, press the key simultaneously, and rotate it counterclockwise to the “” position, and the direction can be locked; if users need to unlock, rotate the key clockwise.



Position	Function	Notes
	Used in parking (vehicle is powered off)	Key can be removed
	Used in starting or driving	Key cannot be removed
	Use when locking the vehicle (the vehicle is powered off and the direction is locked)	Key can be removed



▲ Warning

- During the parking (including parking for a long time), the ignition switch must be in the “” or “” position to ensure the safety of the vehicle and prevent the battery from “losing power”.
- Do not push the motorcycle while the steering mechanism is locked, otherwise it will be out of balance.

Start The Engine



Regardless of whether the engine is cold or hot, please follow the instructions below to start the engine.

1. Turn the ignition switch to the “” (ON) position.
2. Make sure that the engine switch is in the “” (ON) position.
3. Shift the gear to neutral, or pull the clutch lever and retract the side stand, then start the motorcycle with the transmission in gear.
4. With the throttle fully closed, press the starter button to start the motorcycle.

If the engine fails to start:

If the engine does not start within 3 seconds, wait for 10 seconds before repeating step 4.

Notes

- If the engine starts but idles unevenly, slightly increase the throttle.
- Prolonged high-speed idling and rotation can harm the engine and exhaust system.
- Sudden acceleration or prolonged idling at high speed for more than 5 minutes may cause the exhaust pipe to discolor.
- If the throttle is fully open, the engine will not start.

Shift Gears

Your motorcycle features 6 forward gears with a 1-down, 5-up shifting pattern.

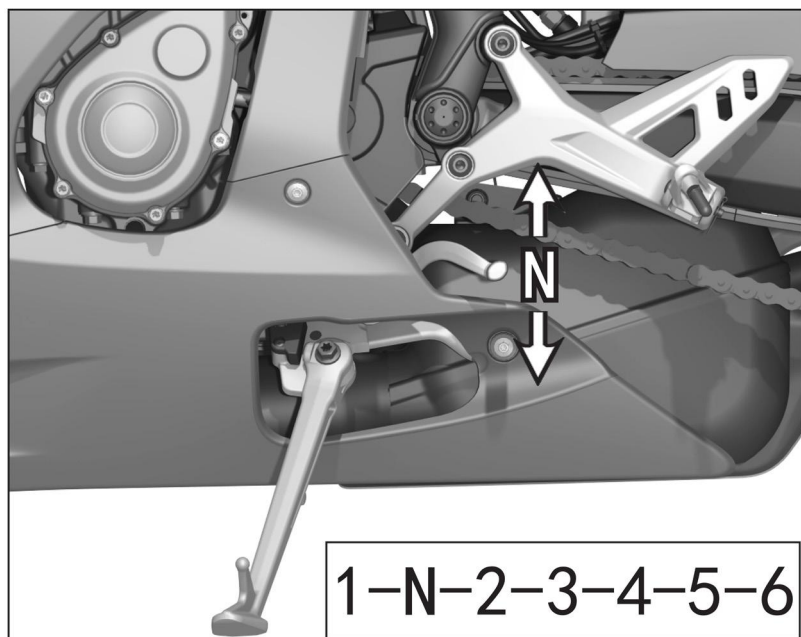

How to shift gears:

Warm up the engine to ensure smooth operation.

1. When the engine is idling, disengage the clutch and press the gear shift pedal downward to engage the low gear (1st gear).
2. Gradually increase the engine speed while slowly releasing the clutch lever, coordinating these two actions to ensure a smooth start.
3. When the motorcycle reaches a steady riding state, reduce the engine speed, disengage the clutch, and lift the gear shift pedal to engage the 2nd gear, and so on.

Things to pay attention to while driving:

1. Avoid unnecessary engine idling, and do not allow the engine to idle at high speeds, as this can severely damage the components.
2. Driving with the clutch partially engaged will quickly wear out the clutch plates.
3. If you feel the engine lacks power while climbing a slope, promptly shift to a lower gear.
4. While riding, especially when going downhill or at high speeds, do not use only the front brake or coast in neutral, and do not ride without holding the handlebars.
5. When stopping, reduce the throttle, disengage the clutch at the same time, and then apply the brakes.

Quick Shift System

The motorcycle is equipped with a quick shift sensor, enabling you to upshift swiftly without using the clutch. As the throttle handle does not need to be closed, you can shift gears seamlessly and continuously.

- ▶ This function will not operate when upshifting with the throttle off.
- ▶ When operating the clutch lever, this function will not operate.
- ▶ When starting the vehicle or powering it on, ensure the shift lever is in a free state and avoid operations such as pedal use, which may cause errors in the initial position self-learning of the quick shifting sensor. If quick shifting cannot be performed in any gear due to the malfunction of sensor self-learning, you can try restoring this function by powering the vehicle off and then power on again.
- ▶ To ensure the proper operation of the quick shift function, when using this feature to shift gears, make sure the shifting action is continuous and complete. Avoid incomplete shifting operations, as the ECU may exit the torque control function, resulting in a failed shift.
- ▶ If the quick shifting sensor is not running properly, you can also use the clutch to complete the shifting operation.

During daily maintenance, ensure the quick shift sensor remains clean (free of stains, sand, metal shavings, etc.) to maintain proper functionality.

Develop good riding habits during regular rides. After shifting, promptly move your foot to the pedal and avoid placing it above or below the shift lever to prevent accidental shifting. Practice this function regularly to become familiar with its features and fully leverage its capabilities.

Traction Control System (TCS)

The motorcycle is equipped with TCS (Traction Control System), which allows the motorcycle to achieve optimal traction during driving. It effectively suppresses the rear wheel slippage during starts, sudden acceleration, etc., on slippery surfaces (such as ice, snow, rain, muddy), thereby improving driving stability and safety.

You can turn the TCS function on or off through instrument settings. It is recommended to keep the TCS function on unless there are special circumstances. When TCS is turned off and the rear wheel loses grip, the system will not request torque reduction, which may cause the vehicle to yaw or crash. The rider should adjust their riding style accordingly.

On slippery surfaces, TCS will not operate due to the engine's inherent braking intervention. If you suddenly decelerate by releasing accelerator, it may cause uncontrollable rear wheel slippage. Do not suddenly close the accelerator, especially when riding on slippery surfaces.

TCS may not be able to handle rapid refueling operations on rough roads. When accelerating, please consider the road and weather conditions, as well as your skills and physical condition. If motorcycle is stuck in mud, snow, or sand, temporarily turning off the TCS can make it easier to get motorcycle out. Turning off the TCS helps maintain control and balance during off-road riding.

Always use the tire specifications, wheel speed sensors, and ring gears recommended by KOVE to ensure the TCS run properly.

When the TCS function is active, you may feel a weaker power output from the vehicle. This is normal and there is no need to worry or take any additional measures.

Notes

- While riding, if TCS indicator comes on, it may indicate that you have turned off the TCS function or that the TCS function has malfunctioned. Please turn off the key switch, then turn it back on, and also turn on the ignition switch on the right handlebar. If the indicator still remains on after the vehicle speed exceeds 5km/h, it indicates an abnormality in the TCS function. Please take the vehicle to an authorized KOVEMOTO motorcycle service center as soon as possible for troubleshooting.

Refueling

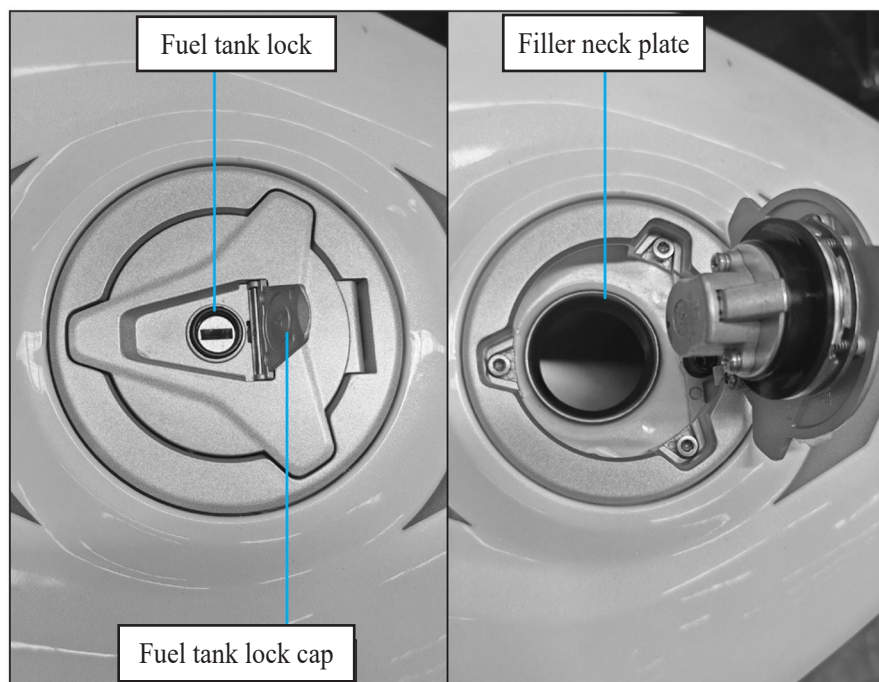

Open the fuel tank cap:

Lift the lock cover, insert the ignition key, and turn it clockwise to open the fuel tank cap.

Close the fuel tank cap.

1. After refueling, press down the oil tank until it locks.
2. Remove the key and close the oil tank.

When refueling:

After stabilizing the motorcycle with side stand, open oil tank cap for refueling. Do not refueling above the filler neck plate. The fuel tank capacity is 17 liters. The capacity of the fuel tank is 20 L. It is recommended to use 92# or above unleaded gasoline. After the fuel is filled, close and lock the fuel tank cap.

⚠ Warning

- When not refueling, the fuel tank lock cover must seal the keyhole to prevent mud or water from entering the lock cylinder and causing damage.
- When refueling, always do so outdoors, ensure the engine is turned off, stay away from heat sources, sparks, or open flames, and immediately wipe up any spills.

Maintenance

Please carefully read the "Maintenance" and "Maintenance Guidelines" sections before preparing for maintenance.

Maintenance.....	31
Maintenance Interval Table	32
Critical Component Torque Periodic Inspection Checklist	33
Maintenance Guidelines	34
Replacement Parts	35
Removal and Installation of Body Components.....	42
Engine Oil.....	44
Coolant.....	46
Brake.....	48
Side Stand	50
Drive Chain.....	51
Clutch.....	53
Accelerator.....	54
Front Shock Absorber Adjustment	55
Rear Shock Absorber Adjustment.....	58
Steering Damper Adjustment.....	61
Headlight	62

Maintenance

The Importance of Maintenance

Always maintain your motorcycle in good condition, as it is essential for your safety, protecting your property, achieving optimal performance, preventing breakdowns, and reducing air pollution.

Maintenance is a crucial responsibility for motorcycle owners. Make sure to perform checks before each ride and conduct regular inspections according to the maintenance interval table.

Please follow these guidelines during maintenance:

- Extinguish the engine and remove the key.
- Park the motorcycle on a firm and level surface using the side stand, or support it with a maintenance stand.
- Wait for the engine, muffler, brakes, and other high-temperature components to cool down before starting operations; otherwise, it may cause burns.
- Start the engine under specified conditions and ensure it is in a well-ventilated environment.

▲ Warning

- Failure to perform regular maintenance before riding or to properly address faults may result in serious or fatal accidents.
- Please follow the inspection, maintenance recommendations, and maintenance interval table provided in the user manual.

Maintenance Interval Table

The vehicle should be serviced within the specified time frame. To ensure safety, only authorized KOVEMOTO service centers are qualified for the maintenance. The meanings of the symbols in the table are as follows:

I: Inspect, clean R: Replace A: Adjust L: Lubricate

Maintenance Item		Odometer					Cycle 1 year	Notes	
		1000Km	1000Km	20000Km	30000Km	40000Km			
★	Throttle control system	I	I	I	I	I	I	After the mileage reaches 40,000 km, maintenance should be repeated at each maintenance interval starting from 10,000 km. ※ This item should be serviced by personnel from an authorized KOVEMOTO Motorcycle service center. If the user has specialized tools, repair accessories, and repair skills, they can also perform the maintenance themselves. Repair instructions can be found in this Instruction Manual. ※※ To ensure safety, this project can only be serviced by authorized maintenance personnel from an authorized KOVEMOTO Motorcycle service center. Notes: 1. When riding in dusty or heavily polluted areas, the air filter element should be cleaned or replaced more frequently to reduce maintenance intervals. 2. When the operating conditions are harsh, the engine oil and filter should be replaced more frequently to reduce maintenance intervals. 3. Brake pad replacement can only be performed by personnel at an authorized KOVEMOTO Motorcycle service center. 4. When the tire wears to the Δ TW ¹ mark on the sidewall or the wear limit indicator at the center of tire, it must be replaced by personnel from an authorized KOVEMOTO Motorcycle service center.	
★	Air filter element		R	R	R	R	R		Note 1
★★	Valve clearance			I/A		I/A	I		
★	Engine oil	Replace every 5000Km after the first service at 1000Km					R		Note 2
★	Oil filter element	Replace the oil at the same time					R		
	Transmission chain	Inspect or adjust after every 1,000 km, after car washing, and after riding in rainy weather or humid areas					I/A		
	Brake pad wear	I	I	I	I	I	I		Note 3
★	Brake system	I	I	I	I	I	I		
★	Clutch	I	I	I	I	I	I		
★	Fasteners		I	I	I	I	I		
★★	Steering bearing	I	I	I&L	I	I&L	I&L		
★★	Tire		I	I	I	I	I		Note 4
★★	Front and rear wheel bearings		I	I	I	I	I		
	Battery	I	I	I	I	I	I		
★★	Fuel system fuel line		I	I	I	I	I		
★★	Fuel filter		R	R	R	R	R		
★★	Spark plug		I	I/R	I	I&R	I&R		
★★	Plain fork bearing		I&L	I&L	I&L	I&L	I&L		
★★	Brake fluid		I	I	I	R	Replace every two years		
	Coolant		I	I	I	R	Replace every two years		

Critical Component Torque Periodic Inspection Checklist

S/N	Name of Fastening Location	Recommended Inspection Material
1	Front and rear wheel axle tightening	Torque inspection is required during each maintenance cycle.
2	Upper and lower triple clamps tightening to secure the front shock absorber.	
3	Upper triple clamp and steering stem tightening	
4	Steering stem 4-slot nut tightening	
5	Handlebar tube socket tightening	
6	Engine sprocket installation tightening	
7	Engine mounting fastening	
8	Rear shock absorber fastening	
9	Front section of muffler with engine	
10	Front and rear brake caliper tightening	
11	Rear brake pump tightening	
12	Shift lever and adjustment rod end bearing tightening	
13	Brake pedal and adjusting lever end bearing tightening	
14	Entire brake line tightening	
15	Fuel rail tightening	
16	Fuel pump tightening	During each maintenance cycle inspection or replacement, perform maintenance according to the specified torque and sealing method.
17	Front and rear brake discs tightening	
18	ABS ring gear	
Note: For torque cycle inspection items not specified in this Instruction Manual, the torque standards shall be followed as per our company's "Maintenance Manual".		

Maintenance Guidelines

To ensure safety, you are responsible for performing a pre-ride inspection and making sure that any issues identified have been resolved. Pre-ride inspection is essential.

Inspection Items	Inspection Details
Handlebar	Smooth and flexible rotation, free from play or looseness
Brake system	Check its operating condition, and inspect the front and rear brake fluid levels and brake pad wear.
Fuel level	Sufficient fuel for the planned journey (refuel if necessary)
Accelerator	Check if it can open smoothly and close completely in all steering positions.
Clutch	Check its operating condition and adjust the free stroke if necessary.
Wheels/tires	Check its usage status and tire pressure, and inflate if necessary.
Drive chain	Inspect its usage condition and sag, and adjust and lubricate if necessary.
Lighting, horn	Check the lighting system and horn to ensure they are functioning correctly.
Engine oil level	Add engine oil as needed and check for leaks.
Instrument Indicators	Check if all indicators on the instrument panel are functioning properly.

Replacement Parts

Battery

Inspect and replace the battery.

1. Before installing the battery, if the electrodes are found to be dirty, clean them thoroughly before installation; otherwise, poor contact may lead to malfunction.
2. If during use, the battery exhibits abnormal phenomena such as deformation, overheating, or smoking, stop using it immediately and have it inspected by an authorized KOVEMOTO Motorcycle service center.
3. If the battery is stored in a high-temperature or humid environment for an extended period, it may malfunction or experience a shortened lifespan. Before reuse, ensure the battery's appearance and functionality are normal.
4. If the vehicle fails to start, check whether the battery is functioning properly. If the battery is damaged, replace it immediately.
5. When installing the battery, ensure the battery terminal bolts are securely tightened.

If the battery is not used for an extended period, please note the following:

- To prevent over-discharge, the battery should be charged every two months.
- When the battery is not in use, it should be stored in a cool, dry environment, and the positive and negative terminals should be protected from short-circuiting.

Notes

- Improper handling of batteries may harm the environment and human health. Please dispose of used batteries in accordance with local environmental regulations.
- The addition of electrical appliances may cause battery drain and even electrical system malfunction.

Fuse

Fuses protect your motorcycle's electrical circuits. If any electrical components of your motorcycle stop functioning, inspect and replace the blown fuse.

Inspect and replace the fuses

Turn the ignition switch to the “” (off) position, then remove and inspect the fuse. If the fuse is blown, replace it with a fuse of the same specification. Refer to the “Technical Parameters” section for the fuse Parameters.

If the fuse blows frequently, there may be a hidden issue with the electrical system. Please have it inspected by an authorized KOVEMOTO motorcycle service center.

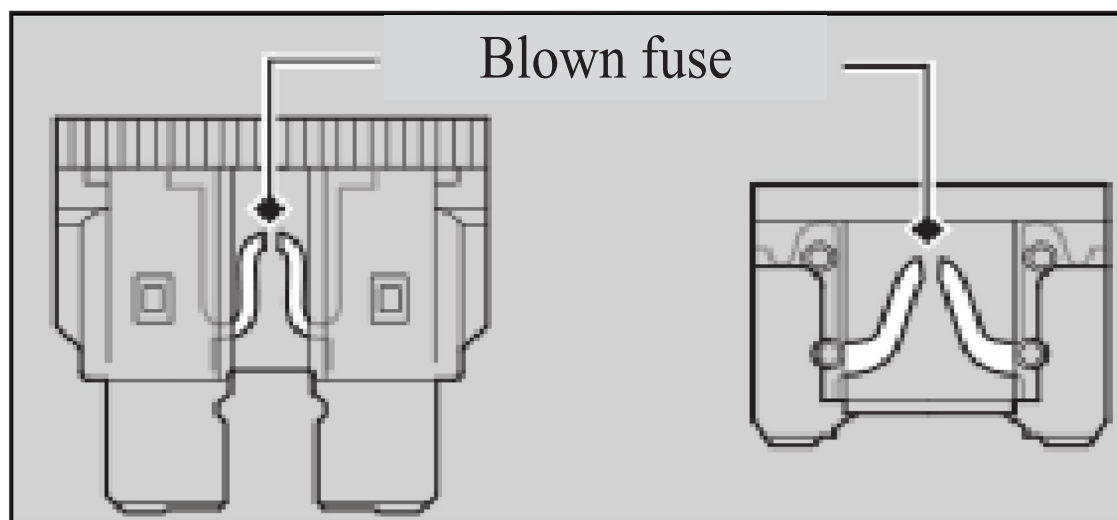

Notes

- Fuses must be replaced with ones of the same rating. Using a fuse with a higher rating increases the risk of damaging the electrical system and may pose a fire hazard.
- Installing non-KEVOMOTO electrical accessories can overload the electrical system, lead to battery discharge, and even damage the system.

Engine Oil

Engine oil consumption and degradation vary depending on riding conditions and usage duration. The higher the engine speed, the faster the oil consumption rate. When operating at high speeds or high RPM for extended periods, shorten the oil change interval. Regularly check the engine oil level and add the recommended engine oil if necessary.

When used in extreme temperatures, oil degrades more rapidly. Dirty or aged oil should be replaced promptly.

Choosing Engine Oil

The initial engine oil should be SN_10W/50, and the maintenance engine oil should be API-classified SN grade or higher.

Notes

- Brake fluid can damage plastic and painted surfaces. If spilled, wipe it off immediately and clean thoroughly.
- Recommended brake fluid: DOT4 or equivalent.
- Use coolant specifically designed for non-aluminum engines, as ordinary tap water or mineral water can cause corrosion.

Brake Fluid

Do not add or replace brake fluid except in an emergency. Only use brake fluid that has been freshly taken from a sealed container. If you have added brake fluid, please have the brake system inspected by an authorized KOVE-MOTO Motorcycle service center as soon as possible.

Coolant

Only use the original undiluted KEVO Motorcycle pre-mixed coolant, which offers superior protection against corrosion and overheating. Regularly check the coolant level and promptly add more if it falls below the minimum mark. The coolant has a freezing point of -40°C and a boiling point of 110°C.

Drive Chain

The drive chain must be regularly inspected and lubricated. If frequently ridden on poor road surfaces, at high speeds, or with repeated rapid acceleration, the chain should be checked more often.

If the drive chain does not operate smoothly, produces unusual noises, has damaged rollers or loose pins, or missing or bent seals, have the chain inspected by an authorized KOVEMOTO Motorcycle service center.

Also inspect the drive sprocket and driven sprocket. If either shows wear or damaged teeth, have them replaced by an authorized KOVEMOTO Motorcycle service center.

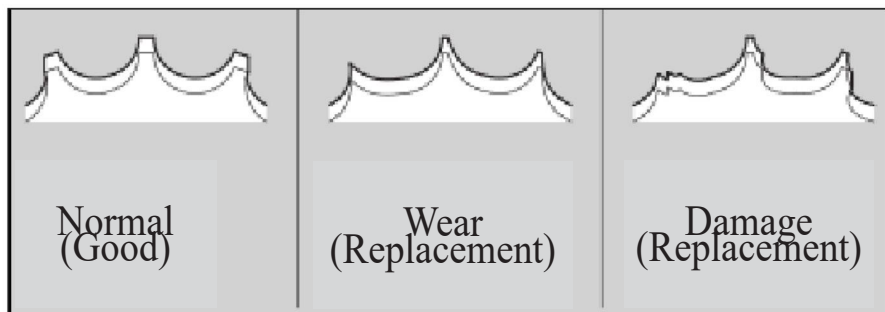

Notes

- Using a new drive chain on worn sprockets will accelerate chain wear; both the drive chain and sprockets should be replaced simultaneously.
- Recommended lubricant: Specialized lubricant for chain oil seals.

Cleaning and Lubricating

After checking the sag, clean the chain and sprockets while rotating the rear wheel using a dry cloth, a chain cleaner for sealed chains, or a neutral detergent. If the chain is dirty, use a soft brush. After cleaning, dry it and lubricate with the recommended chain oil.

Avoid using steam cleaners, high-pressure cleaners, wire brushes, volatile solvents like gasoline and benzene, scrubbing agents, chain cleaners, and lubricants that are not specifically designed for oil-sealed chains, as they may damage the chain oil seals.

Avoid getting lubricant on the brakes or tires, and refrain from using excessive lubricant to prevent it from splashing onto clothing or the motorcycle.

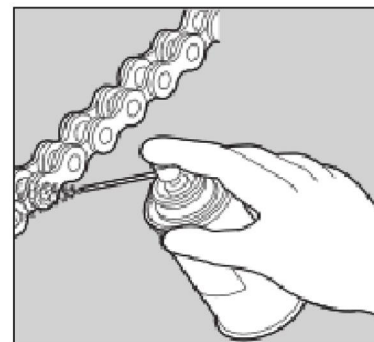

Tire (Inspection/Replacement)

Tire specifications

Front tire: 120/70 ZR17

Rear tire: 160/60 ZR17

Abnormal wear check

Inspect the tire's contact surface for any signs of abnormal wear.

Inspect the tread depth

Check the tread wear indicator marks; if the wear reaches the indicators, replace the tire immediately.

Check the tire pressure

When you feel the tire pressure is low, measure it with a pressure gauge. Check the tire pressure when the tires are cool, and do this at least once a month. Ensure the valve core cap is securely tightened; replace it with a new one if necessary.

The standard tire pressure is: Front tire: 230 kPa; Rear tire: 250 kPa.

Check the damage

Inspect the tires for cuts, cracks, exposed fabric, tire cords, nails, or other foreign matters embedded in the sidewall tread, and also check for any abnormal bulges or swelling on the tire sidewall.

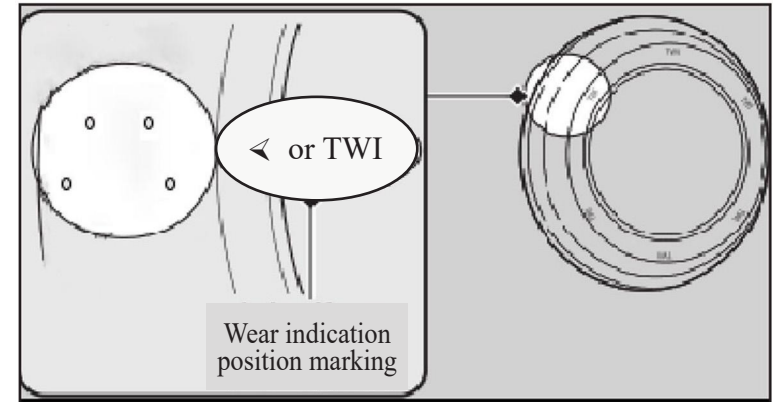

Whenever replacing tires, follow these guidelines:

- Use the recommended tires or equivalent products with the same size, structure, speed rating, and load capacity.
- After installing the tires, use the original KOVEMOTO motorcycle wheel balancer or equivalent equipment to balance and align the wheels.
- This motorcycle rim is designed for use with inner tubeless tires. Do not install Inner tube in tire yourself. If Inner tube is installed, it will rub against rim during rapid acceleration or braking, and the excessive heat will cause Inner tube to burst.

▲ Warning

- Using excessively worn or improperly inflated tires can lead to accidents, resulting in serious injuries or fatalities. Please follow the relevant tire inflation and maintenance guidelines provided in the Instruction Manual.
- Installing unsuitable tires can impair handling and stability, potentially causing accidents and even endangering lives.
- Always use the tire size and type recommended in this Instruction Manual.

Air Filter

This motorcycle is equipped with a paper air filter element. Do not perform maintenance yourself. It should be cleaned or replaced by an authorized KOVEMOTO Motorcycle service center.

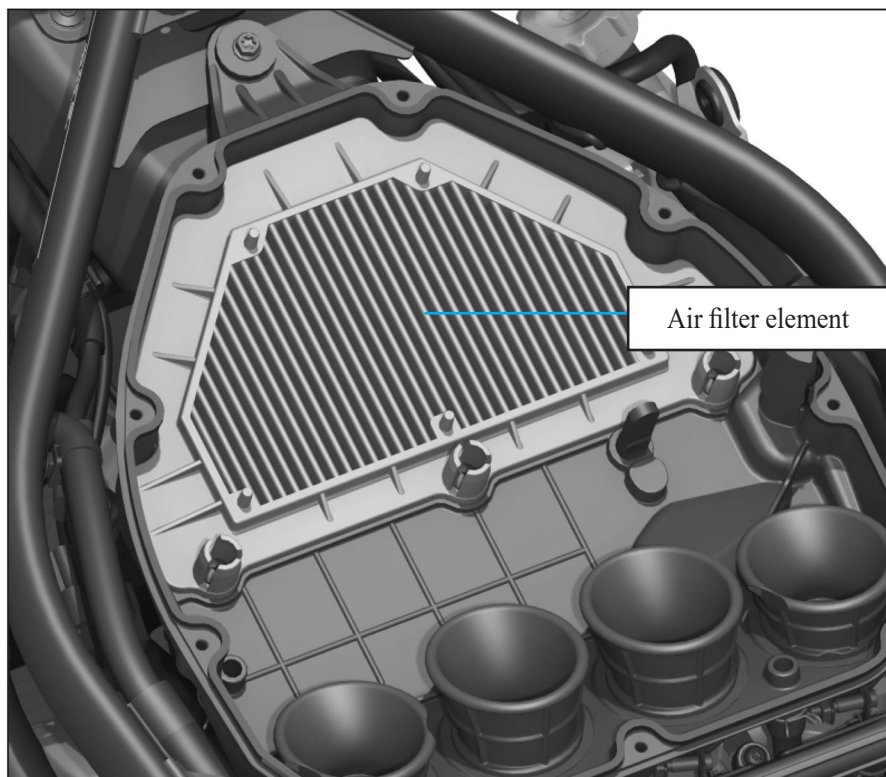

Tools

The onboard tools are embedded under seat cushion towards the back.

You can use the onboard tools to conduct some simple repairs, fine-tune, and replacement of parts.

- Double-ended internal torx wrench T25×T30

Removal and Installation of Body Components

Battery

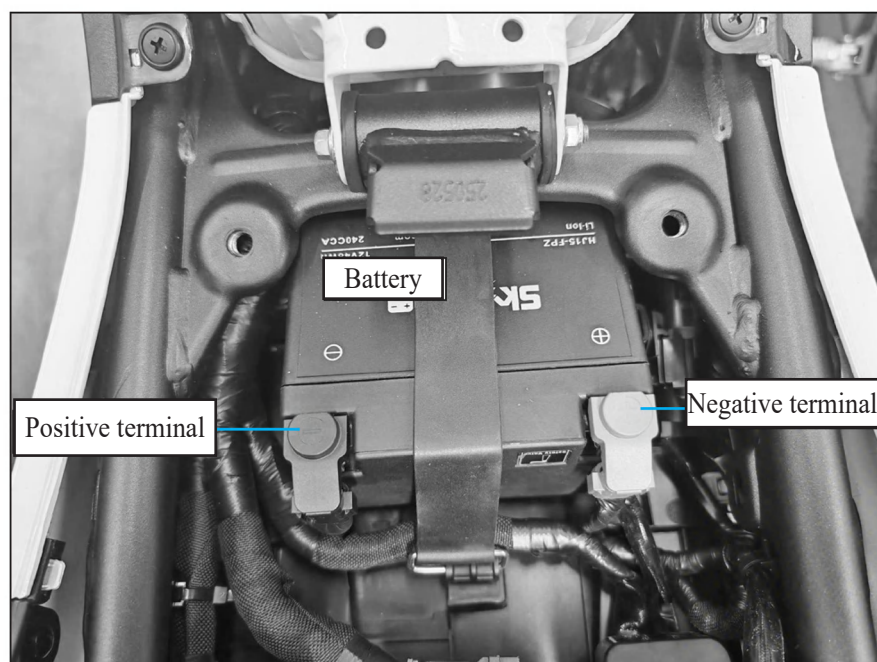

Disassembly

Make sure the ignition switch is turned to the “OFF” (OFF) position.

- 1.Remove the seat cushion.
- 2.Release the rubber strap from the back.
- 3.Disconnect the negative (-) terminal of the battery.
- 4.Disconnect the positive (+) terminal of the battery.
- 5.Remove the battery, being careful not to leave the bolts and nuts.

Installation

Install all parts in the reverse order of removal, ensuring to connect the positive terminal (+) first and the negative terminal (-) last; ensure that the bolts and nuts are tightened.

Seat Cushion

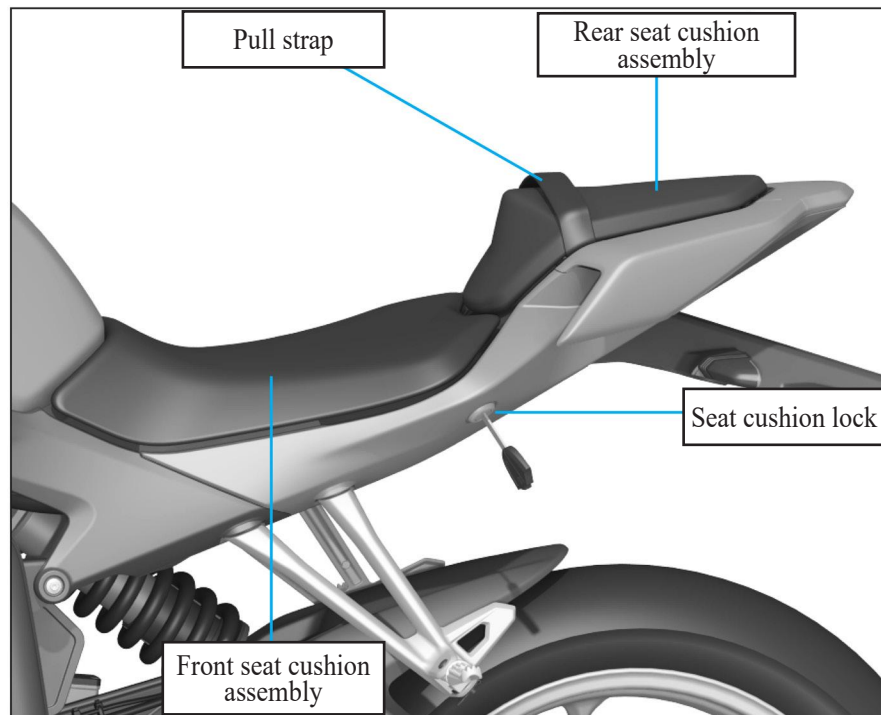

Disassembly

1. Insert the ignition key into the seat cushion lock, rotate the key clockwise, and at the same time, apply slight force to the front end of the rear seat cushion assembly. Then, lift the front end upwards to disengage it from the lock and pull straps, and finally remove the rear seat cushion assembly.
2. Use the onboard tools to remove bolt at the rear left and right of seat cushion, then lift it up.

Installation

1. Align the rear end of the front seat cushion assembly with the rear hole positions and install the screws.
2. Insert the front and rear pins of the rear seat cushion assembly into the frame slot respectively.
3. Align the seat lock pin with the lock hole, press the rear part of the seat downward, insert the lock pin into the lock hole of the seat lock and lock it automatically by the lock tongue, and pull it up slightly to ensure that the seat is firmly locked in place.
4. When the seat cushion is closed, the seat cushion will automatically lock.

Notes

- Ensure the seat pin is securely inserted into the frame slot; otherwise, the seat may not support your weight and could be damaged.

Engine Oil

Inspect and top up engine oil

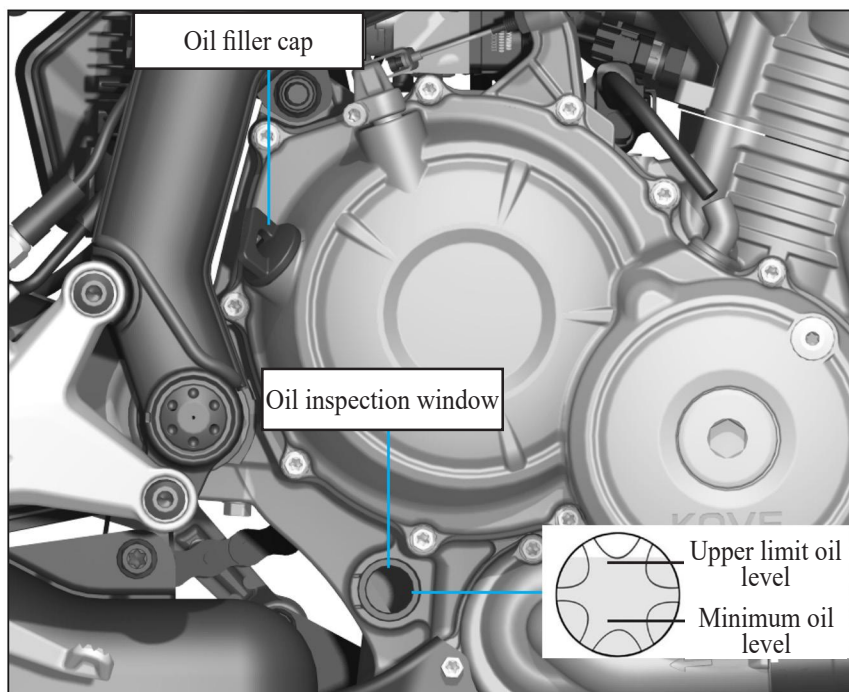

Check the engine oil

1. Let the engine idle for 3 - 5 minutes, turn the ignition switch to the “OFF” position, and then wait for 2 - 3 minutes.
2. Place the motorcycle vertically upward on a stable and flat ground, remove the left windshield and check whether the oil level is between the upper and lower limit mark from the engine oil inspection window.

Add the engine oil

When the engine oil level is below or close to the lower limit mark, add the recommended engine oil.

1. Remove the engine oil filler cap, add the recommended oil to the upper mark of the oil level. Do not exceed the upper limit mark, and ensure that no foreign matters enter the engine oil filler. If there is any spillage, wipe it off immediately.
2. Reinstall and tighten the engine oil filler cap.

Notes

- Long-term skin contact with oil shall be avoided. Wash thoroughly after contact with oil.
- Overfilling or underfilling the oil will damage the engine. Do not mix oils of different brands and grades, as this will affect lubrication and clutch operation.
- The used engine oil and container are harmful to health and the environment. They cannot be disposed of as household waste and should be handled in accordance with local environmental regulations.

Replace the engine oil and the oil strainer

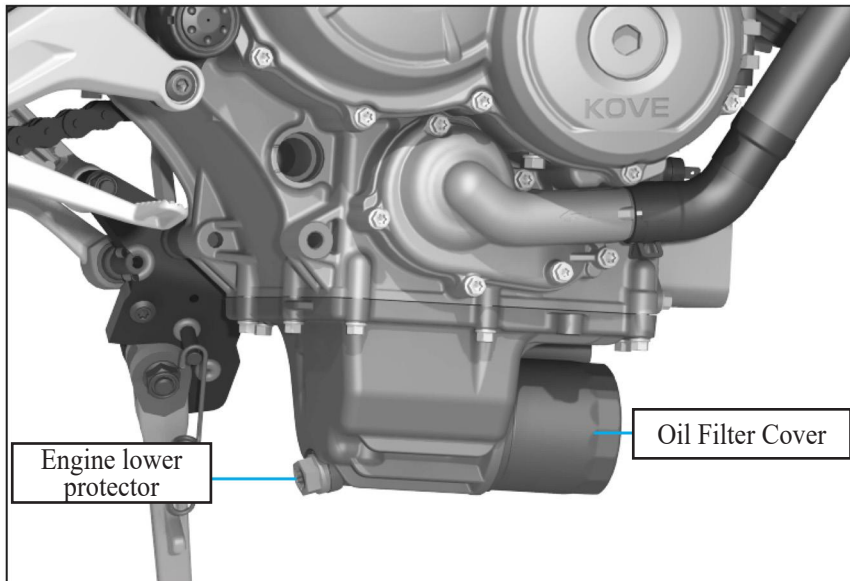

Replace the engine oil and the oil filter

Special tools are required to replace the engine oil and the oil filter. We recommend that the inspection and maintenance be completed by an authorized KOVEMOTO motorcycle service center. Please refer to the “Maintenance Interval Table” for the maintenance interval of engine oil and oil filter.

1.If the engine is cold, please idle for 3-5 minutes, turn the ignition switch to the “” (OFF) position, and then wait for another 2-3 minutes.

2.Park the motorcycle on a stable, level surface and place an oil drain pan beneath the drain bolt.

3.Remove the filler cap, oil drain bolt, and sealing washer, then drain the engine oil, ensuring the old gasket is not stuck to the engine.

4.Use filter wrench to remove the filter, drain the remaining engine oil, and ensure that the old rubber ring is not stuck to the engine.

5.Apply a thin layer of engine oil to the rubber seal on the new oil filter.

6.Install a new engine oil filter and tighten it (torque: 15 N·m).

7.Install a new sealing washer on the oil drain bolt and tighten the oil drain bolt (torque: 30 N·m).

8.Add the recommended original engine oil into the crankshaft tank, and tighten the oil filler cap after filling.

9.Check the engine oil for leakage.

When replacing the filter element, the required oil level: 2.6 L

When the filter element is not replaced, the required oil level: 2.4 L

When reassembling after disassembling the engine, the required oil level: 2.8 L

Notes

- Using the wrong engine oil and oil filter strainer can seriously damage the engine.
- Dispose of the engine oil and oil filter strainer at the appropriate recycling center.
- Use the specified KOVEMOTO original engine oil and oil filter.

Coolant

Inspect the coolant level

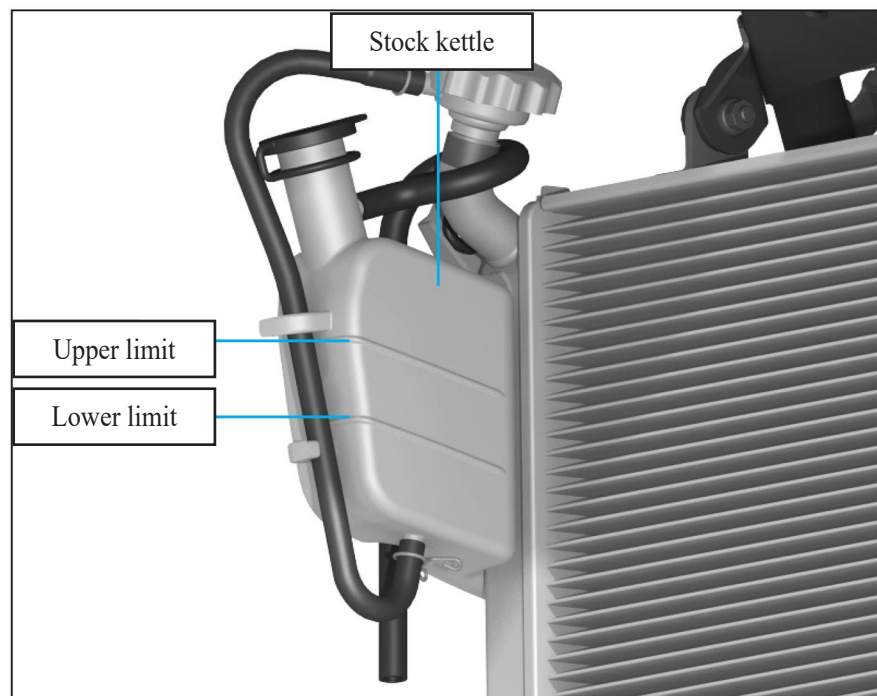

Check the coolant level in the reservoir when the engine is cool.

1. Park the motorcycle on a firm and flat level.
2. Keep the motorcycle upright.
3. Check if the coolant level in the water reservoir is between the upper limit and lower limit marks.
4. If the coolant level drops significantly or the reservoir is empty, there may be a serious leak. Please have it inspected by an authorized KOVEMOTO motorcycle service center.

Add coolant

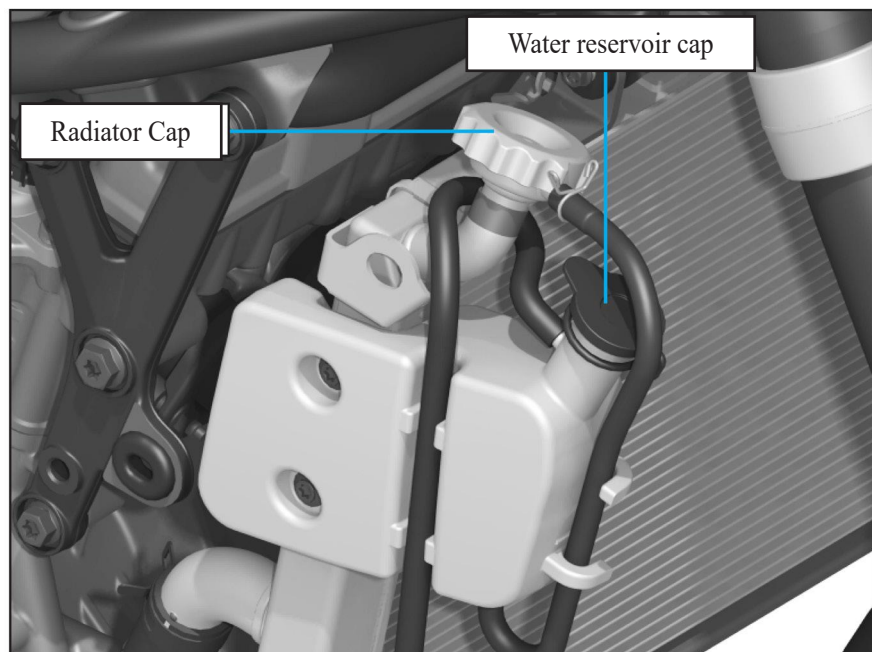

If the coolant is below lower limit, add the recommended coolant until the level reaches upper limit.

When adding the coolant, open the radiator cap to release pressure when the engine is cool, then open the water reservoir at the other end to add coolant. Ensure no foreign matter enter the cap opening and do not exceed upper limit during the process.

After completing the addition, reinstall the relevant caps.

Replace the coolant

Unless you possess the appropriate tools and qualified mechanical skills, please entrust the coolant replacement to the authorized KOVEMOTO Motorcycle service center.

Coolant capacity:

Radiator (including all water channels): 1.5L

Water reservoir (to upper limit level): 0.2L

▲ Warning

- Do not remove the radiator cap while the engine is still hot, as this may cause the coolant to spray out and potentially cause burns.

Brake

Inspect the brake fluid

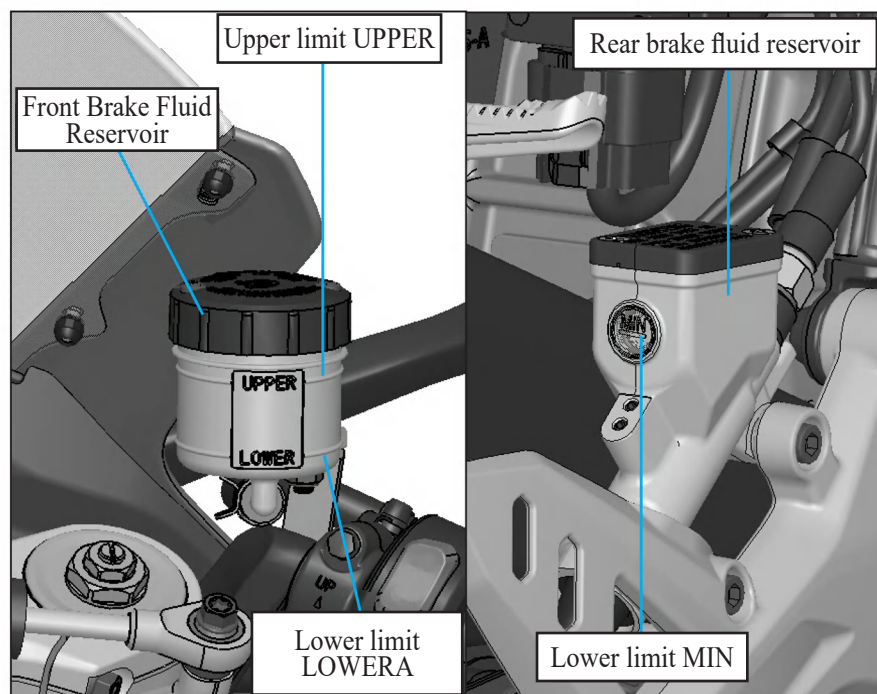

1. Place the motorcycle vertically on a firm and flat ground.
2. Check if the brake fluid reservoirs are horizontal.
3. Check if the brake fluid is visible in the inspection window. If the brake fluid level is below the lower limit of the inspection window, add it immediately.

If the brake fluid level in the oil cup is lower than the lower limit (LOWER) level mark or the free stroke of the brake rod and pedal is out of limit, users must check whether the brake pad is worn. If the brake pad is not worn, there may be leakage. Please have it repaired by an authorized KOVE-MOTO motorcycle service center.

Check the brake pads

Inspect the condition of the brake pad wear indicator. If the brake pad wears down to the indicator mark, it must be replaced.

Front Inspect the brake pad from beneath the brake caliper.
Brake pad lining thickness: 3.5mm (indicator mark indicates the wear limit)

Rear Inspect the brake pad from the right rear of the brake caliper.
Brake pad lining thickness: 6.8mm (indicator mark indicates the wear limit)

If necessary, have the brake pads replaced by an authorized KOVEMOTO Motorcycle service center (when the wear limit is reached, both the left and right brake pads must be replaced simultaneously).

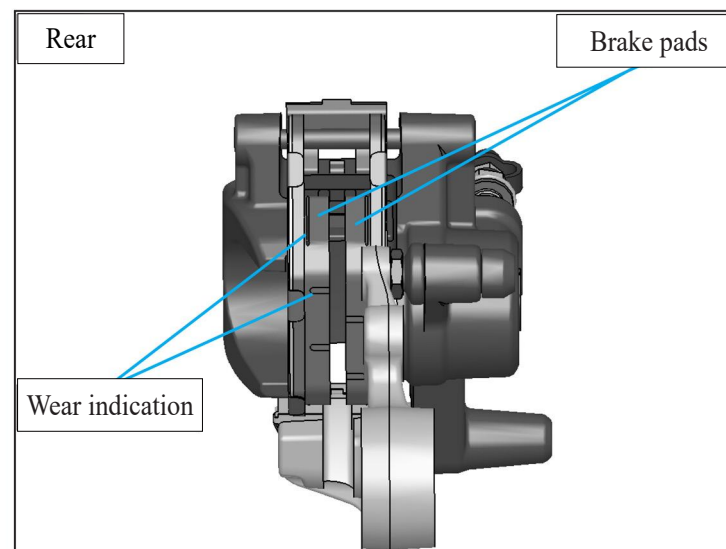
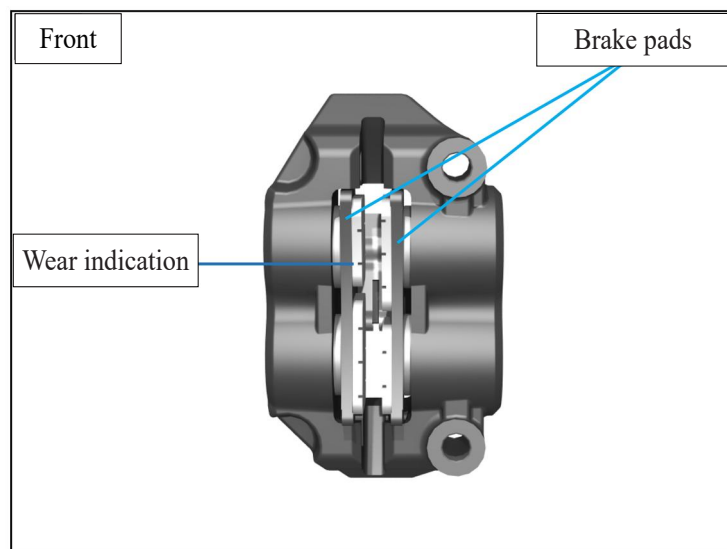

Side Stand

Check side stand

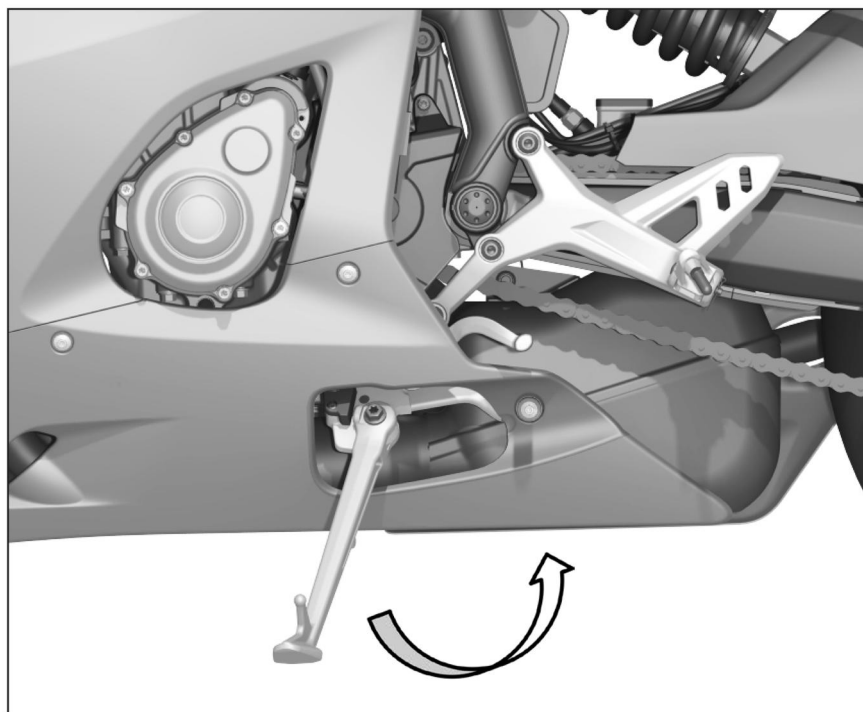

1. Check if the side stand operates smoothly. If the side stand is stuck or makes a squeaking noise, clean the pivot area and lubricate with clean grease.
2. Check the spring damages or inelasticity.

Drive Chain

Check the drive chain sag

Check the sag at various points along the chain. If the sag is inconsistent at any point, some links may be bent or kinked. Please have the chain inspected by an authorized KOVEMOTO motorcycle service center.

1. Put the transmission into neutral and turn off the engine.
2. Place the motorcycle vertically on a firm and flat ground.
3. Determine the chain sag by pushing the chain toward the swingarm in the area behind the chain guard.
4. Rotate the rear wheel forward and check if the chain operates smoothly.
5. Inspect the sprocket.
6. Clean and lubricate the drive chain.

Drive chain sag: 30-45 mm

If the sag exceeds 45mm, you must not continue riding the motorcycle.

Notes

- When inspecting the drive chain sag, ensure that the upper section of the chain is properly tensioned.

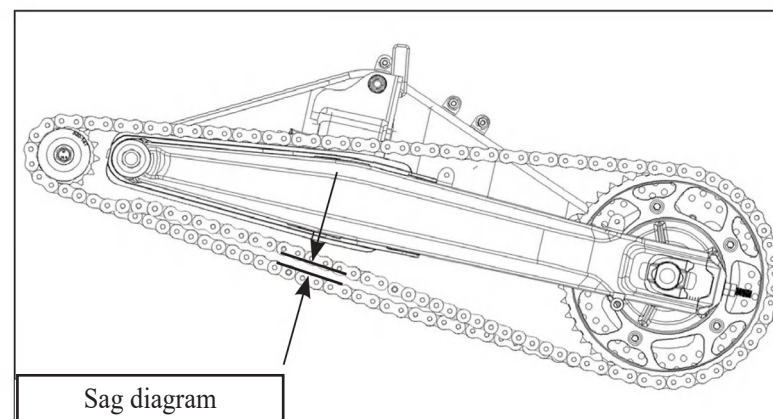

Adjust the sag of the drive chain

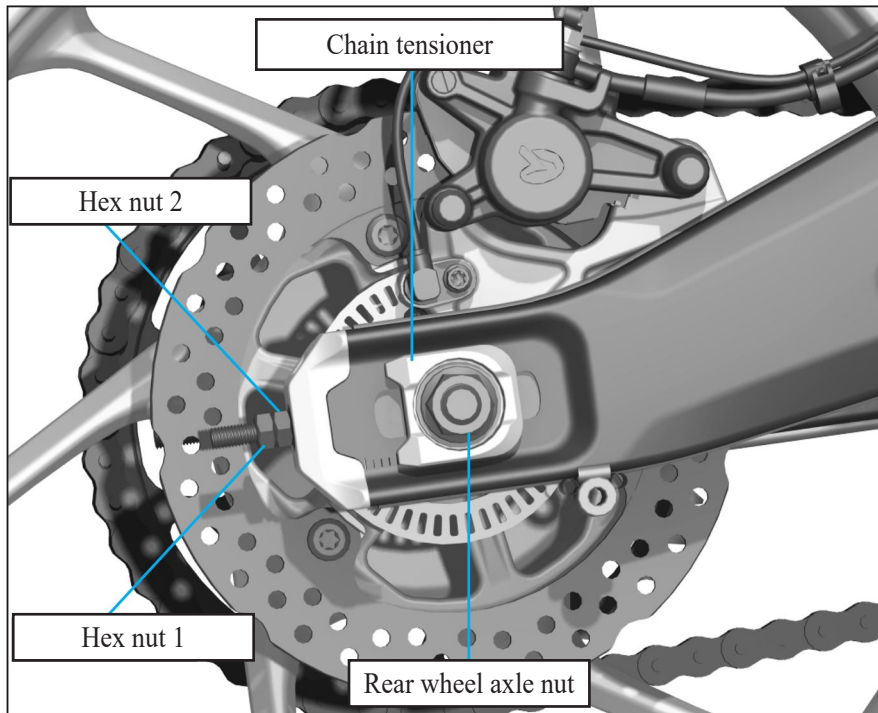

When adjusting the sag of the drive chain:

1. Put the transmission into neutral and turn off the engine.
2. Place the motorcycle vertically on a stable and flat surface, and support the vehicle with the side stand.
3. Loosen the rear wheel shaft and loosen the hex nut 1 on both sides of the swingarm.
4. Adjust the hex nut 2; turning them clockwise will tighten the chain, while turning them counterclockwise will loosen the chain.
5. Rotate hex nut 2 to adjust the chain sag, ensuring left and right on both sides are on sag. The chain sag adjustment range is 30-45mm (see the sag diagram for details).
6. Check the chain tension to ensure it meets the requirements.
7. Tighten the hex nut 1 and tighten the rear wheel shaft nut (Torque: 108N·m).

Notes

- When adjusting the drive chain sag, ensure that the upper section of the chain is taut.

Clutch

Clutch lever free stroke: 10-15mm

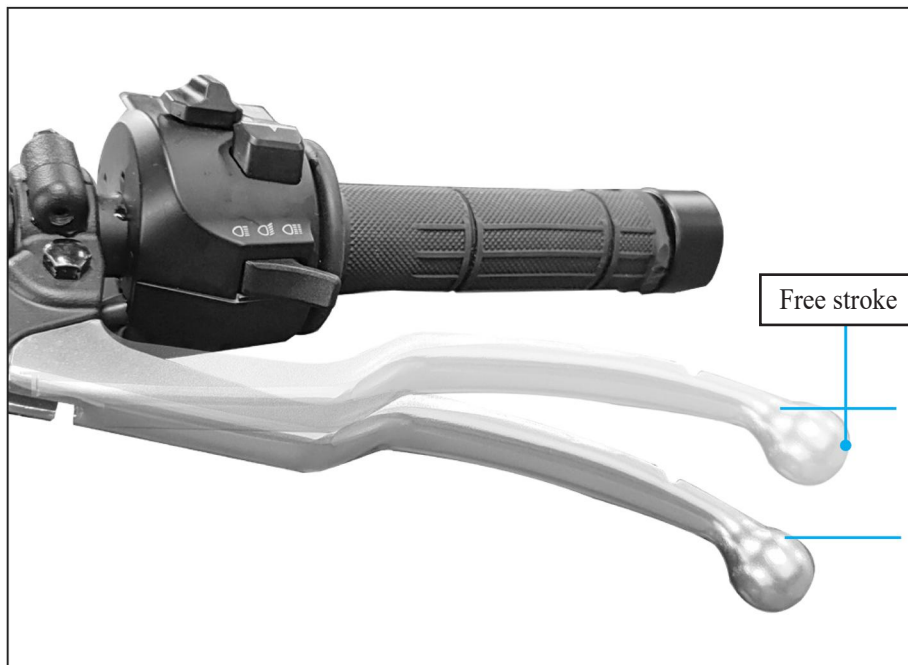

Inspect the clutch cable for any bends or signs of damage. If necessary, have it replaced by an authorized KOVEMOTO motorcycle service center.

Lubricate the clutch cable with a dedicated cable lubricant to prevent premature wear and corrosion.

Notes

- Incorrect adjustment of the free stroke can lead to premature wear of the clutch.

Accelerator

Inspect the throttle

With the engine off, check if the throttle can smoothly transition from fully closed to fully open in all handlebar positions and if the free play is correct.

If the throttle operation is not smooth, it automatically closes, or the cable is damaged, have it inspected by an authorized KOVEMOTO motorcycle service center.

Free play of the throttle handle flange: 2-6mm

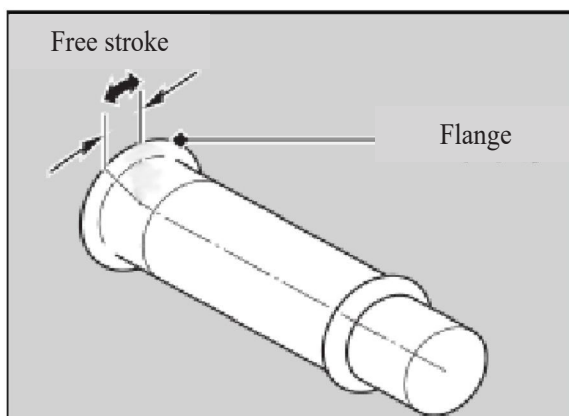

Notes

- Do not turn the adjuster beyond its natural limit.

Adjust the brake handle

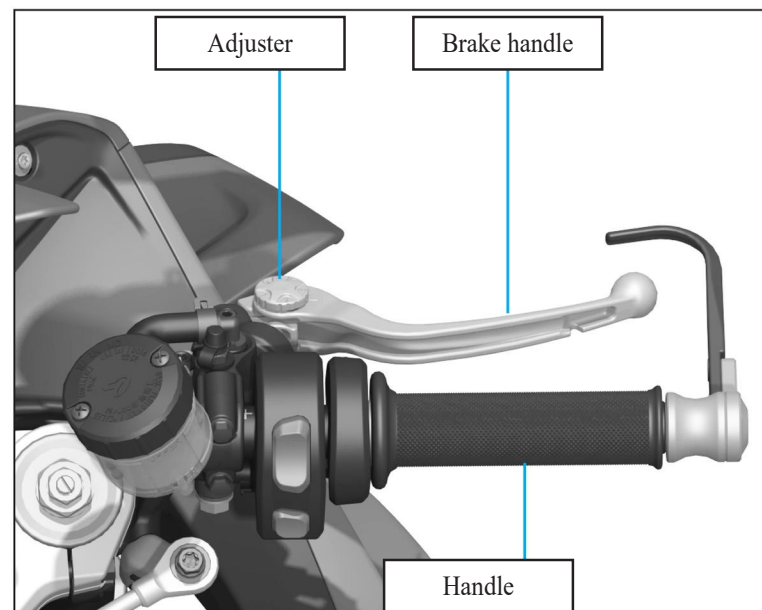

You can adjust the distance between the top of the brake handle and the handlebar grip.

Adjustment method

Push the hand brake lever outward to the desired position while rotating the adjuster until the numbers align with the markings. After adjustment, check whether the brake handle works correctly before riding.

Front Shock Absorber Adjustment

Compression Damping Adjustment

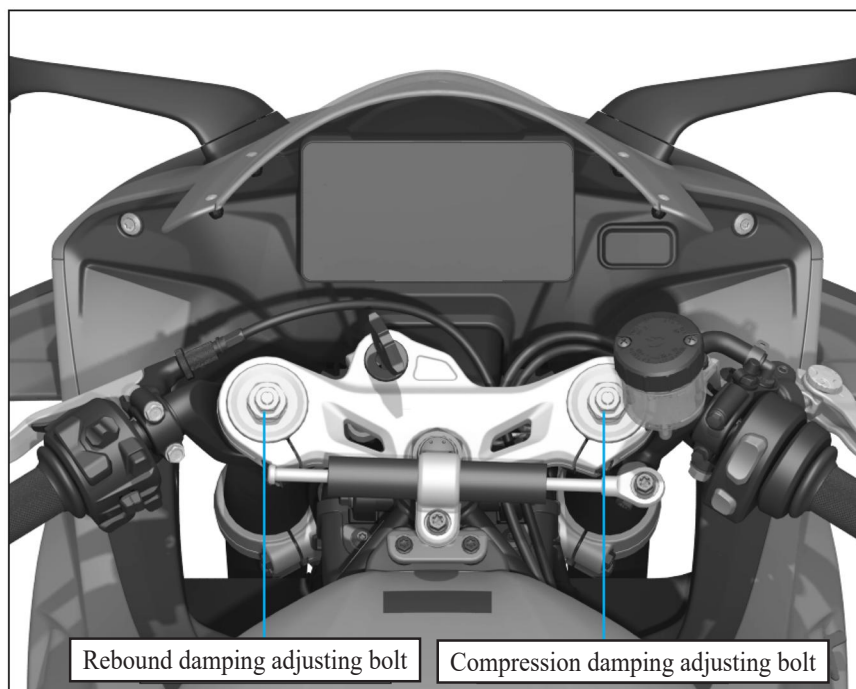

The adjustment of the compression damping affects the speed at which the front shock absorber compresses. The front shock absorber's compression damping is located on the right side of the shock absorber and is engraved with "COMP". Adjust the slotted part of the stud center.

The compression damping has 13 clicks. Rotating the adjusting bolt clockwise (H) increases compression damping, while rotating it counterclockwise (S) decreases compression damping.

Set standard compression damping:

1. Clockwise rotate the compression damping adjusting bolt until it cannot be rotated.
2. Rotate the adjusting bolt in a counterclockwise direction. The standard compression damping is set by rotating it 7 clicks counterclockwise from the fully tightened position (where a click sound is heard).

You can adjust it according to your weight and riding conditions, ensuring the adjusting bolt stops at the clicking position each time.

Notes

- Do not apply excessive torque to the adjusting bolt, as it may damage the adjustment device. The adjusting torque shall not exceed 0.5N·m.

Rebound Damping Adjustment

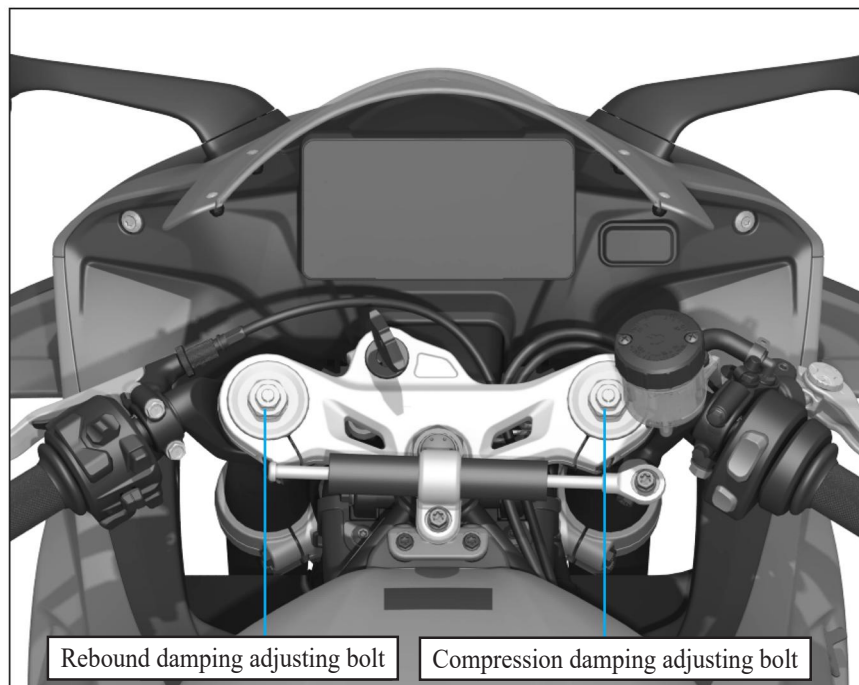

The adjustment of rebound damping will affect the rebound speed of the front shock absorber. The rebound damping of the front shock absorber is marked “TEN” on the left side of the front shock absorber. Adjust the slotted part of the stud center.

The front shock absorber has 13 rebound damping clicks. Rotating the adjustment bolt clockwise (H) increases rebound damping, while rotating it counterclockwise (S) decreases rebound damping.

Set the standard rebound damping:

1. Clockwise rotate the spring-back rebound damping adjusting bolt until it cannot be rotated.
2. Rotate the adjusting bolt in a counterclockwise direction. The standard rebound damping is set by rotating it 7 clicks counterclockwise from the fully tightened position (where a click sound is heard).

You can adjust it according to your weight and riding conditions, ensuring the adjusting bolt stops at the clicking position each time.

Notes

- Do not apply excessive torque to the adjusting bolt, as it may damage the adjustment device. The adjusting torque shall not exceed 0.5N·m.
- By turning the adjuster clockwise, both compression damping and rebound damping can be

Spring Pre-Compression Adjustment

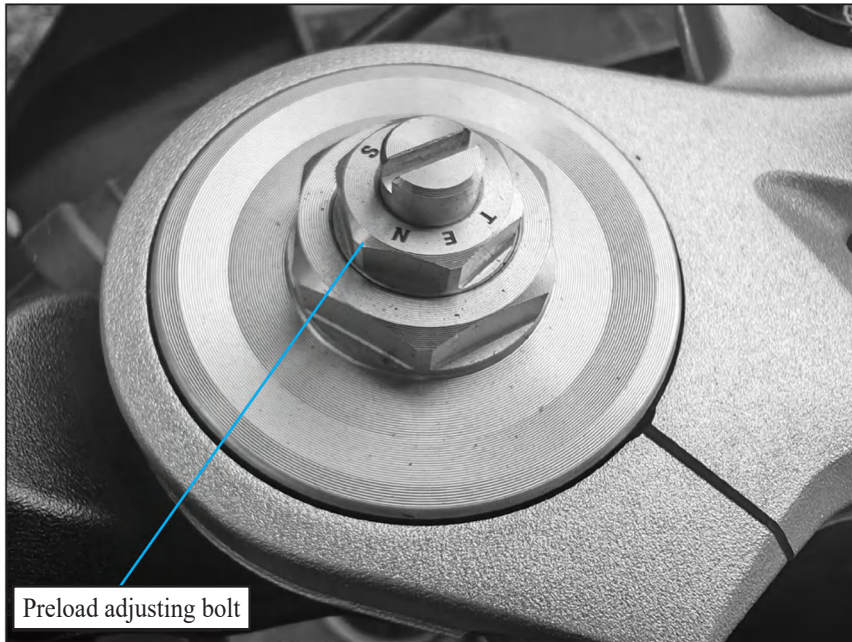

Spring pre-compression adjustment affects the force required to compress the spring. The higher the pre-compression, the greater the force required for the spring to compress the same distance; the lower the pre-compression, the less force the spring needs to compress the same distance. Adjust the hexagonal part of the front shock absorber stud.

Rotate the pre-compression adjusting bolt clockwise to increase spring preload, and rotate it counterclockwise to decrease spring preload.

Each turn of the spring preload adjustment increases or decreases by 1 mm, with a maximum adjustment range of 15 mm. Do not force the adjustment.

You can make adjustments based on your weight and riding conditions. Ensure that after each adjustment, the bolts on left and right shock absorbers are set to the same position.

Rear Shock Absorber Adjustment

Airbag

The rear shock absorber assembly includes a shock airbag containing high pressure nitrogen. Do not attempt to remove, repair or dispose of the device. Piercing or exposure to flame may also cause an explosion, causing serious injury. Repair or disposal should be completed by special repair shop of KOVEMOTO.

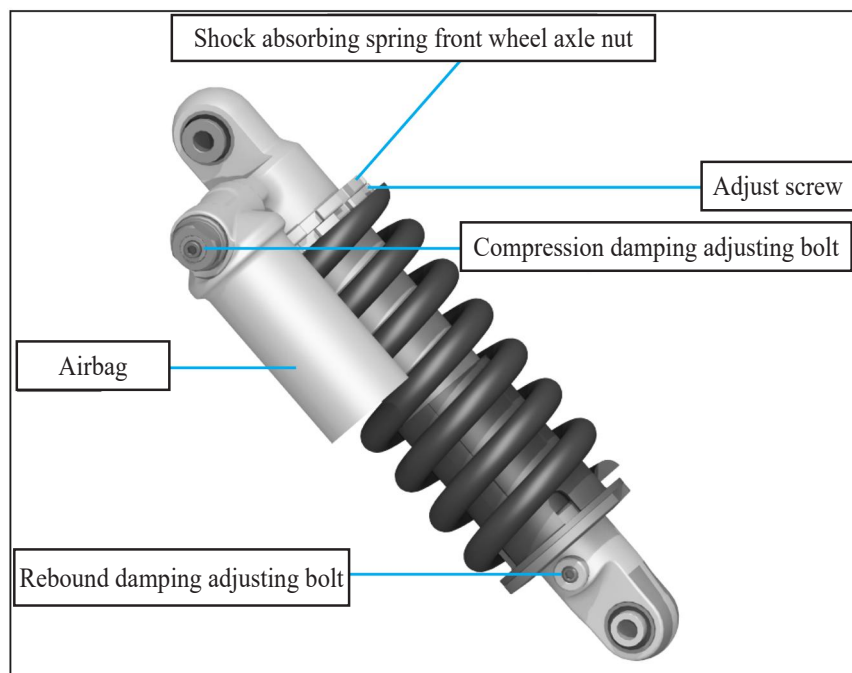

Spring Preload Adjustment

Adjust the spring preload after the engine has been stationary for some time. Loosen the shock absorber spring locking nut, then rotate the shock absorber spring preload adjusting nut to adjust the spring preload.

Rotate the knob clockwise to increase the spring preload and reduce the spring length.

Rotate the knob counterclockwise to reduce the spring preload and increase the spring length. The spring (standard) length after preload compression is 154 ± 1.5 mm.

After the adjustment is completed, hold the adjusting nut and tighten the shock absorber spring lock nut (torque: 35 ± 3 N·m).

Compression Damping Adjustment

The compression damping adjusting bolt is located at the upper left of the rear shock absorber, with 24 clicks of compression damping. The compression damping increases after clockwise (H) adjustment, and the compression damping decreases after counterclockwise (S) adjustment.

Set standard compression damping:

1. Rotate the adjusting bolt clockwise (H) until it cannot be rotated.
2. Rotate the adjusting bolt counterclockwise for 8 clicks from the hardest position.

Rebound Damping Adjustment

The rebound damping adjusting bolt is located at the lower left end of the rear shock absorber, with 24 clicks of rebound damping. Rotating the adjusting bolt clockwise (H) increases rebound damping while rotating it counterclockwise (S) reduces rebound damping.

Set the standard rebound damping:

1. Rotate the rebound damping adjusting bolt clockwise (H) until it cannot be rotated.
2. Rotate the adjusting bolt in a counterclockwise (S) direction. The standard rebound damping is to rotate 8 clicks counterclockwise from the hardest position (where a click sound is heard).

Notes

- Gently rotate the adjusting bolt to prevent damage to the shock absorber.
- When adjusting compression damping or rebound damping, always use a properly sized tool to avoid damaging the device.
- Make sure that the adjusting bolt is firmly in the fixed position during each adjustment.
- The adjusting torque for compression damping and rebound damping shall not exceed 0.5 N·m.

Shock Absorber Inspection

Check and clean all parts of the shock absorber regularly to ensure optimum performance:

1. Check that the front shock absorber dust seal are clean and that there is no soil or dirt on the front shock absorber.
2. Check for oil stains under the spring strut dust seal. If there are signs of oil leakage, replace the damaged dust seal and oil seal.
3. Pinch the hand brake lever and press the handlebar back and forth several times to check whether the front shock absorber rebounds smoothly.
4. Press the seat cushion several times to check whether the rear shock absorber works smoothly.

Steering Damper Adjustment

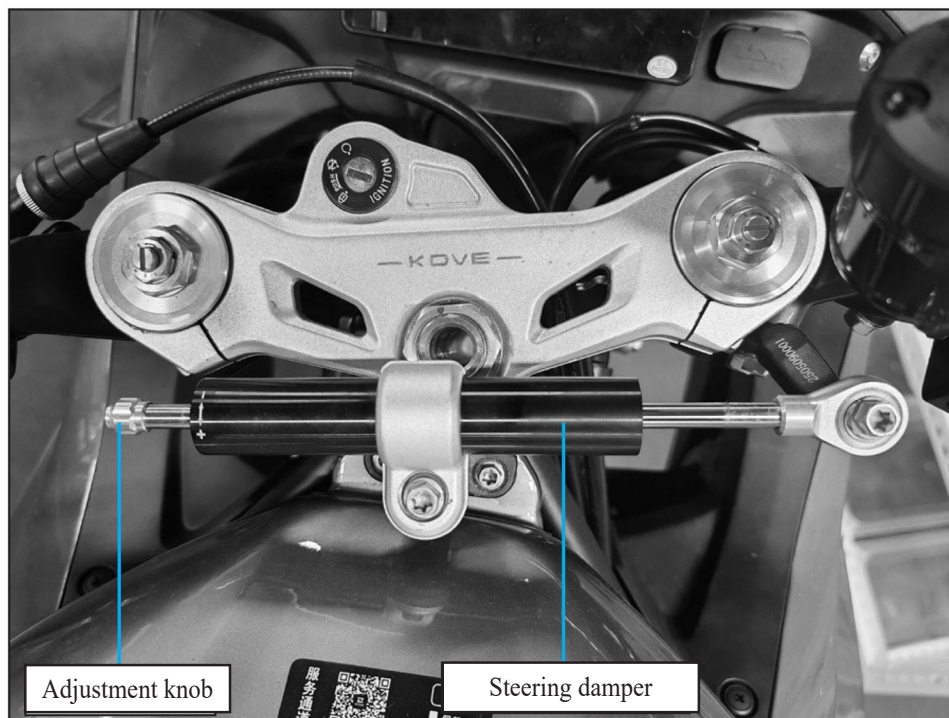

Adjustment knob

Steering damper

The motorcycle is equipped with a steering damper, which effectively stabilizes the handlebars. You are not needed to feel the damping; it's already working, starting conservatively and gradually adjusting to your individual requirements.

The damping of the directional damper increases when the “+” direction adjustment knob is rotated.

Adjusting in the “-” direction reduces damping, resulting in a softer feel.

You will feel a “click” as you turn the knob. The adjustment knob clicks 6 times per full turn.

Rotate the knob's starting position 8 clicks back off from the full “+” direction. We recommend starting here and riding for a while before conducting adjustments.

When rotated to the end point in the “+” direction, this position indicates the maximum damping value. Please avoid adjusting the damping to this setting during your initial ride. Once you're accustomed to your directional damper, try adjusting it one bar at a time until you find your preferred setting.

⚠ Warning

- Please check the settings before each ride!

Headlight

Adjust the headlight beam

You can adjust the angle of the headlight beam by rotating the adjusting screw, and the clockwise rotation is the overall rise of the headlight beam; The counterclockwise rotation is the overall decline of the headlight beam. Please comply with local laws and regulations.

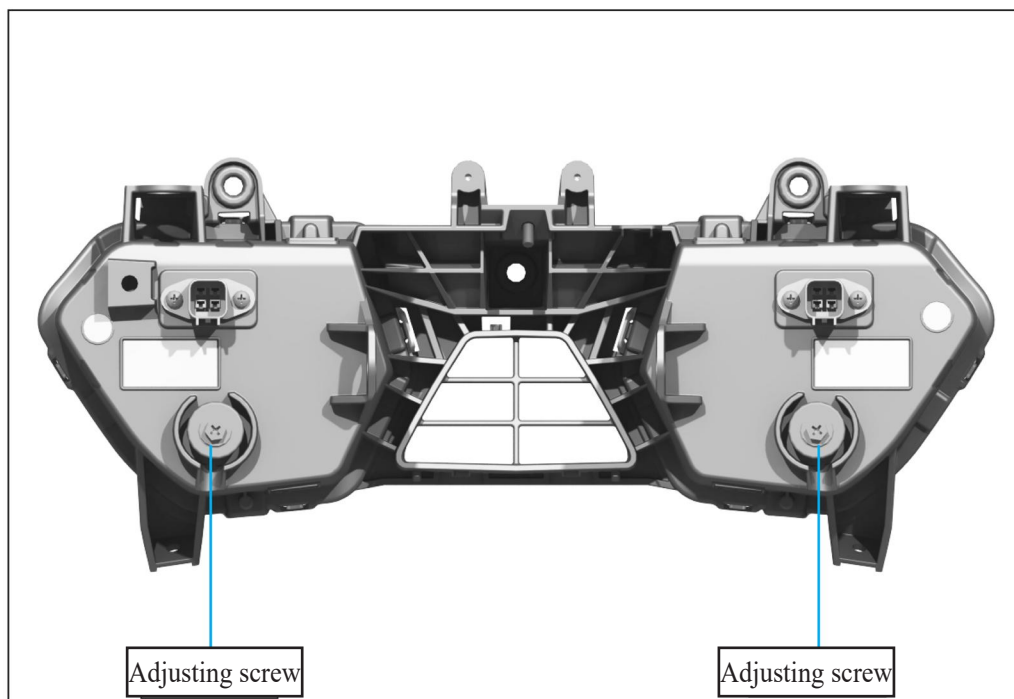

Fault Handling

The Engine Fails to Start	64
The Warning Indicator is On or Flashing	65
Puncture	67
Removing the Wheel	68
Electrical Malfunction	72

The Engine Fails To Start

Engine no-start (starter motor operates)

Inspect the following items:

- Verify that the correct engine start sequence is being conducted.
- Check if there is fuel in the tank.
- Check whether the battery voltage is too low.
- Check if side stand retracted.

Starter motor failure

Inspect the following items:

- Verify that the engine start sequence is correct.
- Ensure that the engine OFF switch is in the operating position.
- Check whether the battery voltage is too low, the fuse is blown, or the battery connection is loose. If the problem persists, please have it inspected by an authorized KOVEMOTO motorcycle service center.

The Warning Indicator is On or Flashing

Oil pressure indicator

If the oil pressure indicator is on, push the motorcycle to a safe side of the road and turn off the engine, and take the following measures:

1. Check the engine oil level and add oil if necessary.
2. You can continue to ride only after the indicator goes out.
3. When the oil is at or near the lower limit, a rapid increase in speed may cause the indicator light to illuminate.
4. If the oil level is at a normal level and the indicator is still on, please turn off the engine and contact the special repair shop of KOVEMOTO.
5. If the engine oil drops quickly, your motorcycle may leak oil or have other serious problems, please send it to the special repair shop of KOVEMOTO.

Electronic injection malfunction indicator light

If the EFI fault indicator comes on while riding, there may be a serious problem with your electronic fuel injection system. Please slow down and have it inspected by a KOVE authorized service center as soon as possible.

Turn indicator light



If the turn signal flashes abnormally or at an increased frequency during use, promptly check for any faults to prevent incorrect signals from causing safety hazards. Besides, have it inspected and repaired at an authorized KOVE motorcycle service center as soon as possible.

Notes

- Continued driving at low oil pressure can seriously damage the engine.



ABS fault indicator (Anti-lock braking system)

If the ABS fault indicator shows any of the following conditions, it indicates a fault in your ABS, and emergency braking will not provide anti-lock function. Please have it inspected by a KOVE authorized service center as soon as possible.

- During riding, the ABS fault indicator stays on or flashes .
- When Ignition is rotated from “” (off) to “” (on), indicator does not come on.
- When the speed is above 5 km/h, the indicator does not extinguish.

The ABS fault indicator may flash or stay on under the following conditions:

- Rotating the front wheel alone.
- Rotating the rear wheel alone.
- The rear wheel gets slippery.
- Riding on special road surfaces.

You can rotate the ignition switch to the “” (OFF) position and then to the “” (ON) position to power on the system.

Water temperature indicator

If the water temperature indicator is on during the ride, push the motorcycle to a safe side of the road and turn off the engine, and take the following measures:

- 1.Wait for cooling down: Do not open the water tank cap immediately (hot coolant can spray out and cause injury). Let the engine sit for at least 30 minutes until the coolant temperature drops to normal.
- 2.Check coolant level: After cooling down, open the water tank cap and check the coolant level. Add coolant if necessary.
- 3.Check for leakages and malfunctions: Inspect the water pipes and water tank for any leakages, and ensure the fans are running properly. If you detect any leakages or fan issues, do not continue riding. Take your motorcycle to an KOVEMOTO authorized repair shop for maintenance.
- 4.Short-distance emergency (only when necessary): If the warning indicator extinguishes after replenishing the coolant and there is no leakage, you may drive at low speed for a short distance to the repair shop. Continuously monitor the temperature gauge during the trip and stop immediately if the warning indicator comes on again.

Notes

- Continuing to ride with an overheated engine can cause serious engine damage.
- Running the engine at high speed in neutral for an extended period may trigger a high coolant temperature alarm.

Puncture

Repairing a flat tire or removing a wheel requires special tools and professional skills. We recommend leaving such maintenance tasks to a KEVO authorized repair shop. If you have performed overtightened tire repair, be sure to have tire inspected or tire replace KOVE authorized service center.

Perform emergency repairs using a tire repair kit.

If your tire has a minor puncture, you can use an inner tubeless tire repair kit to perform emergency repairs.

Follow the instructions provided by the tire emergency repair kit. Riding a motorcycle with a temporarily repaired tire is very dangerous, and the speed should not exceed 50 kilometers per hour. Please have the tire replaced as soon as possible at an KEVO motorcycle repair shop.

▲ Warning

- Riding a motorcycle with a temporarily patched tire is extremely hazardous. If the patch fails, it could lead to an accident, causing severe injuries or fatalities.
- If you must ride a motorcycle with a temporarily repaired tire, ride cautiously and slowly, not exceeding 50 km/h, until the tire is replaced.

Removing The Wheel

If you need to remove the wheel to repair a punctured tire, follow the steps below. Be careful not to damage the wheel speed sensor and ABS ring gear when removing and installing the wheel.

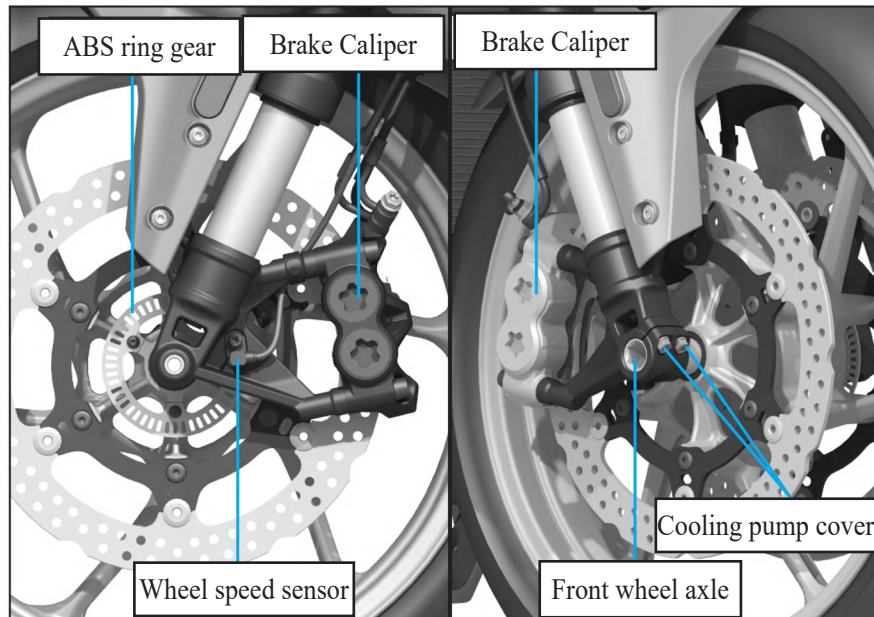

Disassemble:

1. Securely support your motorcycle with a maintenance bracket or a crane and lift the front wheels off the ground.
2. Remove the front fender.
3. Remove the left and right brake calipers.
 - Support the brake caliper assembly well and do not hang it on the brake hose. Do not twist the brake hose.
 - Avoid getting lubricating oil, engine oil or dirt on the brake disc or brake pad.
 - When the brake caliper is removed, do not pull the brake handle.
 - Be careful to prevent the brake caliper from scratching the wheel during removal.
4. Loosen the wheel shaft locking bolt and front wheel axle.
5. Remove the front wheel axle and front wheel.

Installation

1. Clean the front axle and the locking bores of the front shock absorber. Apply grease evenly around the groove between the main and auxiliary lips of the front hub oil seal.
 2. Place the front wheel between the front shock absorber, insert bushing (left) into the mounting bore of the front wheel.
 3. Insert the front wheel axle through the front wheel from right to left and tighten it (front wheel axle M16, torque 70 ± 2 N·m).
 4. Place the front wheel on the ground, then shake the front fork up and down a few times to ensure it returns to the correct position.
 5. Install the brake caliper, squeeze the hand brake lever, and tighten the bolts (torque: 45 N·m). Prevent the brake caliper from scratching the wheel during installation. Please use a new assembly bolt when installing the brake caliper.
 6. Install the two right-side locking bolts (front wheel axle locking bolt M8, torque: 22 N·m) and the front fender.
 7. Lift the front wheel off the ground, and after releasing the brake lever, check if the wheel turns smoothly.
- If a torque wrench was not used during the installation process, please take it to an authorized KOVEMOTO motorcycle service center as soon as possible. Improper installation may result in reduced braking performance.

Notes

- When reinstalling the wheel or caliper, carefully position the brake disc between the brake pads to prevent scratching them.
- When installing the front wheel, first tighten the front axle, then secure the lock bolt on the right side of the front axle. The order of these steps cannot be reversed.

Rear wheel

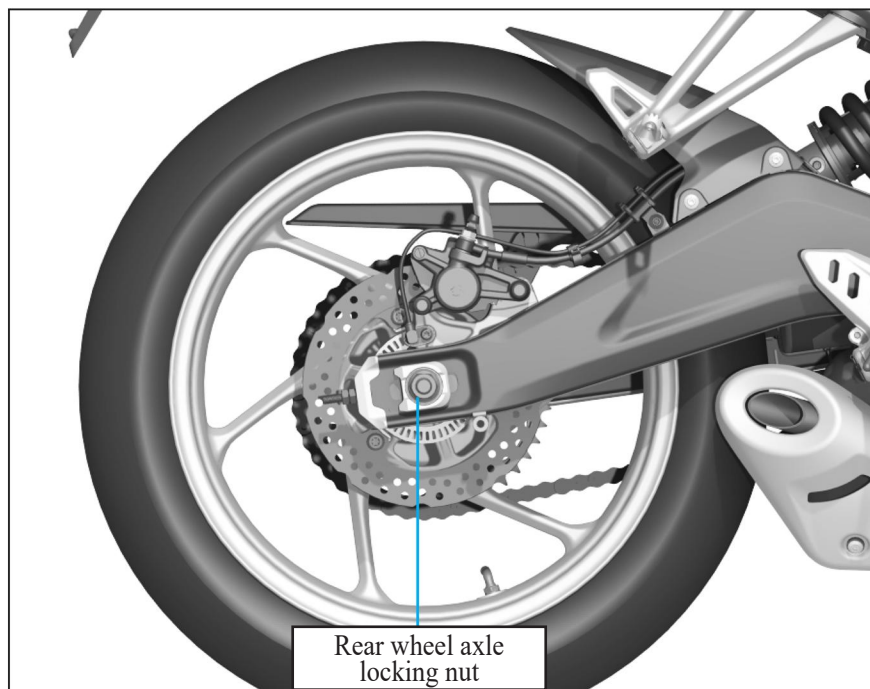

Disassembly

1. Park the motorcycle on a firm and flat level.
2. Firmly support your motorcycle with side stands or service bracket and lift the rear wheel off the ground.
3. Remove the rear wheel axle locking nut and washer.
4. Hold the rear wheel to remove the rear wheel axle and the left and right rear wheel bushings.
5. Withdraw the chain adjusting blocks on both the left and right sides so that the wheel can move forward continuously.
6. Push the rear wheel forward to disengage the chain from the large sprocket.
7. Remove the rear wheel.

Installation

1. Install the rear wheel in the reverse order of removal to prevent the brake caliper from scratching the wheel during installation.
2. Apply the grease evenly on bearing.
3. Align the rear wheel bore with the rear swingarm bore. First, install the rear wheel bushing (the bushing should be lubricated with grease), then insert the rear wheel axle from left to right into the wheel assembly bore.
4. Reinstall the drive chain onto the drive sprocket and adjust the drive chain sag.
5. Tighten the rear wheel axle nut (Torque: 108 N·m).
6. Check if the wheel rotates smooth.

If a torque wrench was not used during the installation process, please take it to an authorized KOVEMOTO motorcycle service center as soon as possible. Improper installation may result in reduced braking performance.

Notes

- When reinstalling the wheel or caliper, carefully position the brake disc between the brake pads to avoid scratches.

Electrical Malfunction

Fuse Blown

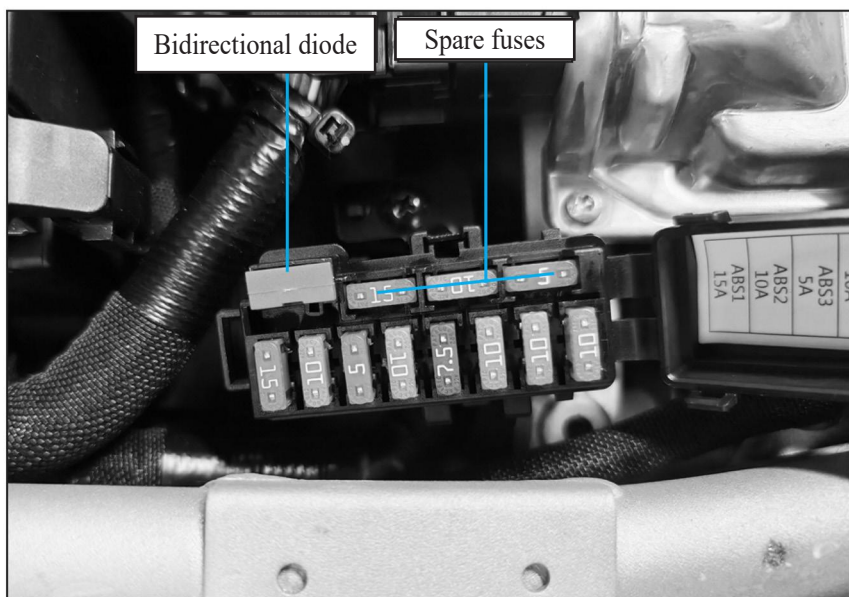

Replace the fuse wire.

1. Remove the seat cushion.
2. Open the fuse box, remove the fuse, and check if the fuse is blown. If blown, be sure to replace it with the fuse with the same specification.
3. Close the fuse box cover and install the seat cushion.

Battery Dead

Please charge the battery using a dedicated motorcycle lithium battery charger. Remove the battery from the motorcycle before charging. If the battery does not recover after charging, please contact the authorized KOVEMOTO motorcycle service center.

Notes

- Avoid using a car battery charger or a motorcycle lead-acid battery charger for charging, as this may result in battery damage or even a fire.
- Before handling the fuse, please refer to “Inspect and replace the fuses”.
- The bidirectional diode is not a fuse; it is part of the starting control circuit. Damage to this component will result in a no-start condition.

Relevant Information

Key.....	74
Instrument, Controls and Other Functions	75
Motorcycle Care	76
Motorcycle Parking	79
Motorcycle Transport	79
You and Your Environment	80
Vehicle Identification Number, Engine Number, Nameplate	81
Catalytic Converter.....	82

Key

Ignition Key



The motorcycle comes with two ignition keys, which are used to start the engine.

- Do not bend the key or subject it to excessive pressure.
- Avoid prolonged exposure to direct sunlight or high-temperature environments.
- Do not grind, bore, or alter its shape in any way.

Notes

- To prevent loss, please keep your key safe. If you are concerned about losing it, make a duplicate immediately.

Instrument, Controls and Other Functions

Ignition Switch, Engine OFF switch

Ignition switch

1. When parked, please set the ignition switch to the “

Engine OFF Switch

Do not use the engine OFF switch unless in an emergency. Doing so while riding will cause the engine to stop suddenly, making the ride unsafe.

Odometer, Trip Meter (Sub-total)

Odometer

When the reading exceeds 999,999, the display will lock at 999,999. Trip Meter

When the reading exceeds 999.9, the display will automatically reset to zero.

Motorcycle Care

Regular cleaning and polishing ensure a long motorcycle lifespan. A clean motorcycle makes it easier to spot potential faults. It is particularly noteworthy that anti-icing seawater and salt scattered on the road can accelerate corrosion. Be sure to clean the motorcycle thoroughly after driving on the coastal or above-mentioned road.

Cleaning

Wait for the engine, muffler, brakes, and other high-temperature components to cool before cleaning.

1. Thoroughly rinse the motorcycle with a low-pressure hose to remove loose dirt.
2. If necessary, use a sponge or soft towel dipped in mild detergent to remove dust and dirt.
3. Thoroughly rinse the motorcycle with ample clean water and dry it using a clean, soft cloth.
4. After drying the motorcycle, lubricate the moving parts, ensuring that no lubricant splashes onto the brakes or tires. Oil-contaminated brake discs, brake pads, brake drums, or brake shoes can significantly reduce braking performance and may lead to accidents.
5. After washing and drying the motorcycle, lubricate the drive chain promptly.
6. Waxing helps prevent corrosion.

Avoid using products containing strong detergents or chemical solvents, as these substances can damage the motorcycle's metal parts, paint, and plastic components. Do not wax the tires and brakes.

If your motorcycle has parts with a matte finish, avoid waxing these matte surfaces.

Cleaning Precautions

- Avoid using a high-pressure water jet:
 - ▶ High-pressure water jets can damage moving parts and electrical components, rendering them irreparable.
 - ▶ Moisture from the intake port may be drawn into the throttle body or enter the air filter.
- Avoid direct water rinsing of the muffler:
 - ▶ Water in the muffler may cause starting problems and rust. If detected, remove all traces and dirt immediately.
- Dry the brakes:
 - ▶ Water reduces braking performance. After washing, intermittently use the brakes at low speed, repeatedly pressing the brake pedal lightly to generate heat from friction, drying the water until braking efficiency is restored.
- Avoid direct water contact beneath the seat cushion:
 - ▶ Water entering under the seat cushion may damage electrical appliance parts.
- Avoid rinsing the air filter directly with water.
 - ▶ If the air filter gets wet, the engine may fail to start.
- Avoid direct water contact near the headlight:

After washing or riding in the rain, the internal lens of the headlight may temporarily fog up, but this does not affect its functionality. However, if you notice a significant accumulation of water or ice inside the lens, have it inspected by an authorized KOVEMOTO Motorcycle service center.
- Avoid waxing or polishing matte finishes:
 - ▶ Use sufficient water and a mild cleanser to clean matte paint surfaces, and dry them with a clean, soft cloth.

Aluminum Components

Aluminum corrodes when exposed to dirt, mud, or salt. Regularly clean aluminum components and follow these guidelines to prevent scratches:

- Avoid using stiff brushes, steel wool, or any abrasive cleaning materials.
- Do not drive or scrape against the curb.

Panel

Follow these guidelines to prevent scratches and damage:

- Gently clean with a sponge and sufficient water.
- Clean with diluted detergent and rinse thoroughly with ample water to remove stubborn stains.
- Avoid exposing the instrument panel and lamp covers to corrosive liquids like gasoline and brake fluid.

Motorcycle Parking

If you leave your motorcycle outdoors, you should consider using a full motorcycle cover. If you do not ride for an extended period of time, please follow these guidelines:

- Wash the motorcycle and wax all painted surfaces (excluding matte finishes), then apply anti-rust oil to all chrome parts.
- Lubricate the drive chain.
- Place the motorcycle on a maintenance stand and elevate it with wooden blocks to ensure both tires are off the ground.
- After rain, remove the body cover and dry it in a ventilated place.
- Remove the battery to avoid discharging.

Fully charge the battery and store it in a cool, well-ventilated area. If you leave the battery in place, disconnect the negative terminal to prevent discharge. Before reusing a stored motorcycle, inspect all items as specified in the maintenance interval table.

Motorcycle Transport

If you need to transport your motorcycle, use a motorcycle trailer, loading ramp, or flatbed truck equipped with a lifting platform, and secure it with motorcycle tie-down straps. Never attempt to tow a motorcycle with its wheels on the ground.

Notes

- Towing a motorcycle can severely damage the drivetrain.

You and Your Environment

Owning and riding a motorcycle is an enjoyable experience, but you must take responsibility for protecting the environment.

Select The Appropriate Detergent

Use biodegradable detergents when washing your motorcycle, and avoid sprays containing chlorofluorocarbons (CFCs) as they harm the protective ozone layer in the atmosphere.

Waste Recycling

Sort the oil and other toxic wastes into approved containers and send them to the recycling center. Call the local national public affairs or environmental service office for the recycling center in your area and the disposal method of non-recyclable wastes. Do not pour used engine oil into trash cans, sewers or ground, because the used oil, gasoline, coolant and cleaning solvent contain toxic substances, which will hurt cleaners, pollute drinking water, lakes, rivers and seas.

Vehicle Identification Number, Engine Number and Nameplate

When registering a motorcycle, you must provide the vehicle identification number and engine number. These unique identifiers are used to distinguish your motorcycle. When ordering replacement parts, ensure you record these numbers and store them in a secure location.

Vehicle Identification Number (VIN)

The VIN is engraved on the right side of the main frame beam

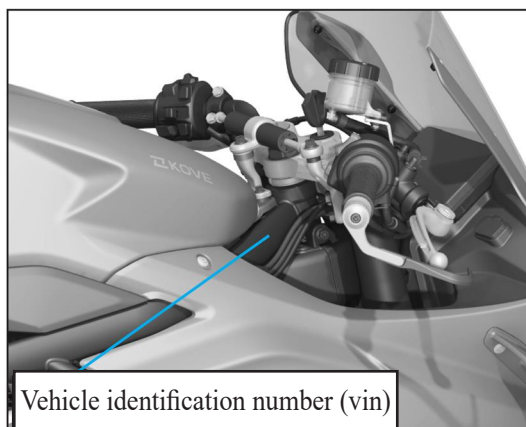

Engine Number

The engine number is engraved on the middle position of the rear side of the engine transmission case

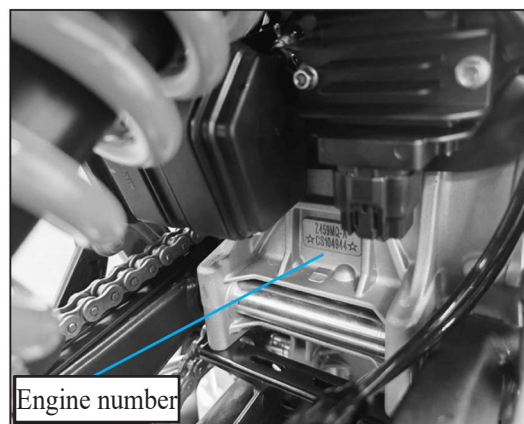

Nameplate

The nameplate is attached to the right side of the main frame beam

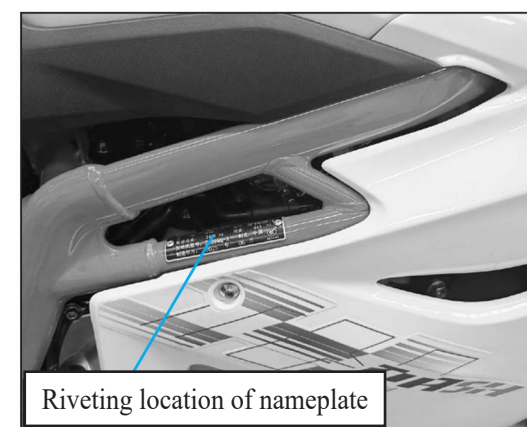

Catalytic Converter

This motorcycle is equipped with a three-way catalytic converter. The catalytic converter contains precious metals as catalysts for high-temperature chemical reactions, transforming hydrocarbons (HC), carbon monoxide (CO), and nitrogen oxides (NO_x) in the exhaust into compliant mixtures.

A faulty catalytic converter can pollute the air and reduce your engine's performance. When replacing it, always use genuine Buick motorcycle parts.

Follow these guidelines to safeguard your motorcycle's catalytic converter:

- Only unleaded gasoline should be used, as leaded gasoline can damage the catalytic converter.
- Maintain the engine in optimal operating condition.
- If the engine fails to start, backfires, stalls, or exhibits other poor performance, stop riding immediately and turn off the engine. Have the motorcycle inspected by an authorized KOVEMOTO motorcycle service center.

Technical Parameters

Vehicle-Related Parameters	84
Torque Parameters	86
Frame Tightening Torque.....	87

Vehicle-Related Parameters -1

Vehicle Model	ZF400GS-C	Engine Model	Z459MQ-C
Overall length (mm)	2015	Cylinder diameter (mm) × Stroke (mm)	59.0×40.5
Overall width (mm)	740	Compression ratio	12.9:1
Overall height (mm)	1090	Maximum power (kw/r/min)	49.0 ± 2% / 13500 ± 1.5%
Wheelbase (mm)	1385	Maximum torque (N·m/rpm)	38.0 ± 2% / 11000 ± 1.5%
Rated passenger capacity (including driver)	2 person	High/low idle speed (rpm)	2500±250/1350±100
Curb weight (kg)	165	Cylinder capacity (mL)	443
Payload (kg)	150	Spark plug	BN9RD
Front tire specifications	120/70ZR17	Spark plug gap (mm)	0.7-0.9
Rear tire specifications	160/60ZR17	Valve clearance (mm)	0.10-0.16
Maximum speed (km/h)	220		0.16-0.22

Vehicle-Related Parameters - 2

Lubricating oil capacity (L)	2.8	Main fuse	40A
Fuel capacity (L)	15	Neutral indicator light	LED lamp
Primary transmission ratio	1.949	Headlight	LED lamp
First gear	2.846	Front position lamp	LED lamp
Second gear	2.056	Rear position lamp/Brake lamp	LED lamp
Third gear	1.632	Front turn signal	LED lamp
Fourth gear	1.381	Rear turn signal	LED lamp
Fifth gear	1.240	Rear license plate lamp	LED lamp
Sixth gear	1.111	Turn indicator light	LED lamp
Final transmission ratio	3.214	Instrument indicator light	LCD lamp
Battery	12V 4Ah (Lithium-ion Battery)	Ignition mode	ECU controls ignition

Torque Parameters

Fastener Type	Torque	Fastener Type	Torque
5mm bolt and nut	6	6mm Screw	8
6mm bolt and nut	12	6mm flange bolt (8mm head, small flange)	10
8mm bolt and nut	22	6mm flange bolt (8mm head, large flange)	12
10mm bolt and nut	60	6mm flange bolt (10mm head) and nuts	12
12mm bolt and nut	80	8mm Flange Bolt and Nut	22
5mm Screw	5	/	/

Notes

- Except for the specified torque, the standard torque values in the above table apply to this vehicle.

Vehicle Body Bolt Torque

Item	Thread Diameter (mm)	Torque (N·m)	Notes
ABS ring gear mounting bolt	M5	5	
Mounting points for ABS hydraulic brake unit and bracket	M6	10	
ABS hydraulic brake unit bracket and frame	M6	10	
Connecting screws between OBD diagnostic interface and rear fender middle section	ST4.8	1	
Mounting screw for fuse box and rear fender front section	ST4.8	1	
Shift rod mounting screw	M6	8	
Shift rod adjusting locking nut	M6	6	
Shift pedal connecting rod and side stand mounting plate	M8	22	
Shift rockerarm and engine gear shift lever	M6	8	
Side cover (left and right) and subframe	M5	6	
Side cover (left and right) and oil tank	M5	6	
Side tilt sensor mounting bolt	M5	2	
Side stand mounting panel and engine	M10	54	
Side stand magnet piece mounting screw	M3	1	
Side stand spring pin and side stand	M10	6	
Side stand mounting bolt (inner thread)	M5	6	
Side stand OFF switch and side stand mounting plate	M4	3	
Special mounting bolts for side stand	M10	22	
Mounting screws for body trim (left and right) and subframe	M6	8	
Body (left and right) and body trim(left and right)	ST4.8	1	

Item	Thread Diameter (mm)	Torque (N·m)	Notes
Vehicle body (left and right) and subframe	M6	8	
Mounting screws for water reservoir and radiator	M6	8	
Headlight bracket and frame upright tube	M8	22	
Headlight bracket and rear section of the air intake duct	M5	6	
Headlight bracket and instrument housing	M5	6	
Rear sprocket connected to buffer	M8	35	
Wingshield(left and right) mounting screw	M5	6	
Windshield(left and right) and windshield lining(left and right)	M5	6	
Ignition lock and upper connection plate	M8	22	
Mounting screws of ignition coil pressure plate and cylinder head	M6	10	
Battery positive and negative terminal bolt connection	M5	2	
Connecting bolts of electrical integration box and frame	M5	6	
Regulating rectifier and frame	M6	10	
Regulating rectifier bracket and frame	M6	10	
Wind wing(left and right) and windshield	M5	5	
Secondary air supply valve	M6	10	
Engine rear suspension mounting points	M10	60	
Engine upper suspension (left and right) and engine	M10	54	
Engine upper suspension bracket (left and right) and frame	M8	26	
Engine upper suspension bracket (left and right) and engine (upper)	M10	54	
Engine upper suspension bracket (left and right) and engine (lower)	M8	26	

Item	Thread Diameter (mm)	Torque (N·m)	Notes
Engine lower protector and engine lower protector (L/R)	M5	6	
Engine lower protector bracket mounting bolt	M6	10	
Engine lower protector (L/R) and windshield (L/R)	M5	6	
Engine lower protector - L/R and engine lower protector (L/R) rear bracket	M5	6	
Engine small sprocket cover mounting bolt	M6	10	
Engine front sprocket locking bolt	M10	55	
Steering handlebars (left and right) mounting bolts	M8	22	
Steering stem locking nut	M24	128	
Connecting bolts between rear fender rear section and subframe	M6	12	
Rear fender inner panel and rear fender rear section	M5	6	
Connecting bolts between rear fender front section and subframe	M6	8	
Rear disc brake and rear wheel hub	M8	35	
Rear reflector mounting nut	M5	5	
Rear grab handle(left and right) and rear grab handle inner lining(left and right)	ST4.8	1	
Connecting bolts of rear shock absorber and frame	M10	54	
Connecting bolts of rear shock absorber and swingarm	M10	54	
Connecting bolts between left and right rear footpegs and subframe	M8	28	
Rear wheel speed sensor mounting screws	M6	8	
Rear wheel axle locking nut	M22	108	
Rear mirror assembly(left and right) and mounting screw	M6	8	
Tailgate mounting screws	M5	6	

Item	Thread Diameter (mm)	Torque (N·m)	Notes
Reservoir groove cover of rear brake pump	M4	2	
Rear brake pump push rod adjustment nut	M6	6	
Mounting bolts of rear brake pump and right front footpeg	M6	12	
Rear Brake hose and swingarm	M5	5	
Rear seat cushion pull strap	M6	8	
Spark plug and cylinder head	M10	12	
Oil pressure sensor	M10	10	
Mounting bolts of throttle intake pipe and engine	M6	10	
Thermostat cover mounting bolt	M6	10	
Intake air temperature sensor and air filter	M6	5	
Intake pressure sensor and electrical integration box	M6	8	
Air filter locking pipe clamp screw	M5	4	
Air filter element mounting screw	ST4.8	3	
Air filter upper housing mounting screw	ST4.8	3	
Connecting bolts of air filter assembly and frame	M6	10	
Air filter element mounting screw	ST4.8	3	
Horn and engine upper suspension bracket - left	M6	8	
Clutch cable lower adjusting nut	M6	8	
Clutch handle mounting bolt	M6	10	
Clutch rockerarm mounting bolt	M5	6	
Chain guard and swingarm	M5	5	

Item	Thread Diameter (mm)	Torque (N·m)	Notes
Chain adjuster locking nut	M8	16	
Chain clip mounting bolt	M6	5	
License plate lamp assembly and rear section of the rear fender	M5	5	
Swingarm shaft locking	M16	88	
Kickstand bushing mounting bolt	M8	16	
Exhaust bolts of front/rear brake calipers	M4	6	
Front headlight assembly and headlight bracket	M6	10	
Headlight assembly and front section of the air intake duct	M5	6	
Front fender assembly mounting bolt	M6	8	
Front disc brake and front wheel hub	M6	15	
Front shock absorber lower tube securing front wheel axle	M8	22	
Mounting bolts of front shock absorber and upper connecting plate	M8	22	
Mounting bolts of front shock absorber and lower connecting plate	M8	22	
Front footpeg brackets (left and right) and frame	M8	22	
Front footpeg bracket-right-mounted return spring	M6	8	
Front footpeg bracket - left and side stand mounting plate	M8	22	
Front wheel speed sensor mounting screws	M6	8	
Front wheel axle locking	M16	70	
Front panel inner lining mounting bolt	M5	6	
Front panel and front windshiled	M4	1	
Front panel and instrument housing	M5	6	

Item	Thread Diameter (mm)	Torque (N·m)	Notes
Front brake pump mounting bolts	M6	10	
Front brake pump oil cup cover	M4	2	
Front brake oil cup and bracket	M6	6	
Front brake caliper mounting bolts	M10	45	
Front seat cushion assembly mounting bolts	M6	8	
Mounting bolts for fuel pump and oil tank	M5	4	
Connecting screws of fuel filter element bracket and fuel pump	M5	4	
Connecting bolts between radiator fan and radiator	M5	6	
Connecting bolts between radiator lower mounting bracket and engine	M6	10	
Connecting bolts between radiator and frame	M6	10	
Connecting bolts between radiator and radiator lower mounting bracket	M6	10	
Brake rockerarm and front footpeg bracket-right	M8	22	
Double wire clip and engine upper suspension bracket - left	M5	5	
Water pump drain bolt	M6	10	
Water temperature sensor	M10	10	
Steering damper mounting bracket and fuel tank	M6	10	
Carbon canister box mounting bracket and frame	M6	8	
Taillight brackets (left and right) and subframe	M6	8	
Taillight bracket (left and right) and taillight assembly	ST4.8	1	
Taillight trim cover and taillight bracket	ST4.8	1	
Wire hook and upper connection plate	M5	6	

Item	Thread Diameter (mm)	Torque (N·m)	Notes
Muffler mounting bracket and engine	M8	25	
Muffler shield mounting screw	M6	8	
Connecting nut between front section of muffler and engine exhaust port	M6	12	
Muffler and muffler mounting bracket	M8	22	
Oxygen sensor and muffler	M12/M18	20 (E5+)/ 50 (INT) Version	
Instrument housing and TFT instrument mounting screws	M5	6	
Mounting bracket for oil cooler (left and right) and engine	M6	10	
Throttle side locking nut of throttle cable	M6	6	
Accelerator cable upper adjusting nut	M6	4	
Front and rear mounting points of fuel tank	M6	10	
Fuel tank lock mounting screws	M5	4	
Oil tank lower protector ornament (left and right) and windshield(left and right)	ST4.8	1	
Connecting bolts of bracket and front brake pump	M6	6	
Connecting bolts of brake switch and rear brake pump	M10	28	
Brake hose and ABS hydraulic unit (oil passing bolt)	M10	32	
Brake hose connecting bolts for caliper and brake pump (oil passing bolts)	M10	28	
Mounting points of main frame and subframe (upper part)	M10	35	
Mounting points of main frame and subframe (lower part)	M10	35	
Steering damper mounting socket and steering handlebar - right	M8	22	
Steering damper and steering damper mounting socket/steering damper mounting bracket	M8	22	
Seat cushion lock and subframe	M6	8	

Item	Thread Diameter (mm)	Torque (N·m)	Notes
Seat cushion trim panel and seat cushion trim (L/R)	ST4.8	1	
Steering stem 4-slot adjusting nut	M25	First stage: 40N·m, second stage: loosen the adjusting nut by two turns and then tighten it to 10N·m, third stage: keep the direction fixed and loosen by 1/4 turn	
Fuel rail and throttle valve	M5	Tighten the two center screws to 5 N·m, then tighten the two side screws to 5 N·m. Next, tighten the center screws to 7 N·m, followed by the side screws to 7 N·m	



<https://www.kovemoto.com>

Version: 11/2024
Tibet New Summit Motorcycle Co., Ltd. All rights reserved.