

## To our distinguished owner

Instruction Manual for The Two-wheeled Motorcycle MX250

Second Edition (March 2024)

First of all, congratulations on your purchase of a brand new KOVEMOTO!

If you choose products of KOVEMOTO, you will become a member of the KOVEMOTO family.

This Instruction Manual introduces the main specifications, basic structure, adjustment method and maintenance knowledge of the motorcycle.

It will guide you to master the basic operation of the motorcycle and eliminate or reduce common faults, which can effectively ensure driving safety, play the best performance of the vehicle, and improve the service life of the vehicle.

**This Instruction Manual contains the introduction of the basic configuration of the motorcycle. The contents and pictures are for reference only, please refer to the physical object.**

**Due to the production time, user needs and design improvements, the actual motorcycle may be different from the contents of the Manual. We reserve the right to make changes at any time, and we will no longer notify and assume any obligations. Sorry for any inconvenience caused.**

The Instruction Manual is one of the necessary accessories of the motorcycle, and when it is sold to others, it should be attached to the motorcycle. The copyright of this Instruction Manual belongs to the company, and no reproduction is allowed without the written consent of the company, and violators will be prosecuted.

To ensure your safety, and increase your riding pleasure:

- Please read the Instruction Manual carefully.
- Please follow all recommendations and procedures in the Instruction Manual.
- Please pay close attention to the safety information recorded in the Instruction Manual and pasted on the motorcycle body.

## Safety Precautions

The safety of you and others is very important, and the safe driving of this motorcycle is an important responsibility.

To help you make an informed decision about your safety, we provide steps and other information on the safety label and in the Instruction Manual to remind you. This information is intended to alert you to the potential danger of harm to you or others.

It is impractical for us to list all the hazards associated with motorcycle riding and maintenance, and you must make the right judgment yourself.

It is forbidden to install electrical equipment, because the battery used in the motorcycle is a lithium battery. Its battery capacity is small, and the installation of electrical equipment may cause a loss of power.

The motorcycle is equipped with a high-speed engine. For your driving safety, it is recommended that you reduce violent driving.

You'll see important security information in a variety of forms, including:

- Safety labels on the body of a motorcycle;
- The safety information is preceded by a safety warning symbol ▲ and one of the following three warnings Caution, danger, and warning.

**▲ Caution** - If you do not follow the instructions, you may be injured

**▲ Danger** - If you do not follow the instructions, you will cause serious casualties.

**▲ Warning** - If you do not follow the instructions, you will cause serious casualties.

**Other important information is listed under the following headings:**

**Notes** -Information to help you avoid damage to your motorcycle, other property, or the environment.

## Contents

Motorcycle Safety	4
Operation Guide	13
Maintenance	25
Troubleshooting	58
Related Information	66
Technical Parameters	74

## Motorcycle safety

This section contains important information about the safe riding of motorcycles, please read this section carefully.

Safety instructions	5
Safety Precautions	8
Riding Precautions	9
Accessories and Modifications	12
Loading Guide	12

## Safety instructions

To enhance your driving safety, please follow these guidelines:

- Perform all routine and routine inspections as specified in the Instruction Manual.
- Before filling the tank, turn off the engine and keep away from sparks and open flames.
- Do not start the engine for a long time in a closed or semi-closed space, because the exhaust gas contains carbon monoxide, which is a toxic gas and can be fatal.

### Always wear a helmet

It has been proven that helmets and protective clothing can significantly reduce the chance of injury to the head and other parts, and reduce the degree of injury. Therefore, please be sure to wear a certified motorcycle helmet and protective clothing when driving.

### Before the ride

Make sure you're in good physical condition, paying attention, and not drinking or taking medication. Make sure that you and your passengers are wearing a certified motorcycle helmet and protective clothing. Make sure your passenger to hold onto the rear grab handle or hold your waist, place his/her feet on the pedals, and lean with you when you turn, even when the motorcycle is stopped.

### Take time to study and practice

Even if you have driven other motorcycles, you should practice riding this motorcycle in a safe area to familiarize yourself with the operation and operation of this motorcycle and adapt to the size and weight of the motorcycle.

### Have a sense of protection when riding

Always pay attention to the vehicles around you, do not think that other drivers can see you, always be prepared to make emergency brakes or avoid detours.

### **Make yourself easier to see**

Especially at night, wear bright reflective clothing to make yourself more eye-catching, stop so that other drivers can see you, turn on the signal light before turning or changing the lane, and when necessary, use the horn to remind pedestrians.

### **Don't drink and ride**

Alcohol and driving are not compatible. Never exceed your personal ability when driving, and do not exceed the speed specified by the vehicle, fatigue and negligence will weaken your ability to make correct judgments and safe driving.

### **Keep your motorcycle in a safe state**

It is important to take good care of your motorcycle so that your motorcycle is always in good condition. Check your motorcycle before each ride and complete all recommended maintenance and repairs. Do not modify motorcycles or add accessories that will affect safety without authorization, and overload is strictly prohibited.

### **Dealing with incidents**

Your personal safety is your first priority. If you or anyone else is injured, you should first carefully evaluate the severity of the injury and determine whether it is safe to continue driving, and call for emergency assistance if necessary. If other persons or vehicles are involved in a collision, the applicable local laws and regulations should also be followed.

If you decide to continue driving, first turn the ignition switch to the “” (off) position, and then evaluate the condition of the motorcycle. Check whether there is oil leakage, check whether the key nuts and bolts are fastened, and check the steering handle, steering column, brake and wheel to ensure that the personnel and vehicle are safe. Please drive slowly and carefully.

Your motorcycle may have suffered damage that will not be immediately apparent, please submit it to a special repair shop or a qualified special repair shop of KOVEMOTO for a thorough inspection as soon as possible.

## Carbon monoxide hazard

The exhaust gas contains toxic carbon monoxide, a colorless and odorless gas, and inhaling higher concentrations of carbon monoxide can cause people to lose consciousness and may even be fatal.

Do not start the engine for long periods of time in a garage or other enclosed space.

### **▲Warning**

- If the engine is started for a long time in a closed or semi-closed space, it may cause a rapid accumulation of toxic carbon monoxide gas.
- Inhaling this colorless, odorless gas causes rapid loss of consciousness and death.
- Motorcycle engines should only be started in well ventilated outdoor areas.

## Safety Precautions

- Be careful when riding, always keep your hands on the throttle grips and your feet on the pedals.
- Make sure that the passenger grasps the grab handle or hugs your waist while driving, and puts his/her feet on the pedals.
- Always pay attention to the safety of riders, passengers and other drivers on the road.

## Protective clothing

Make sure that you and any accompanying passenger are wearing a certified motorcycle helmet, goggles and eye-catching protective clothing, and drive carefully according to the weather and road conditions.

### ■ Helmet

- It is certified to safety standards, eye-catching, and sized to fit your head size.
- It must be safe and comfortable and secured with a chin strap.

### ■ Gloves

High-wear-resistant full-finger leather gloves.

### ■ Boots or riding shoes

Boots that are strong and slip-resistant and protect the ankle.

### ■ Clothing.

It includes a protective eye-catching long-sleeved shirt suitable for riding and wear-resistant pants (or protective suits)

## ⚠ Warning

- Not wearing a helmet increases the chance of serious injury in an accident.
- Make sure that you and your passengers always wear certified helmets and protective clothing.

## Riding precautions

### Run-in period

Follow these guidelines during the first 500 km of driving to ensure the motorcycle's later reliability and performance.

- Avoid full throttle start or rapid acceleration.
- Avoid emergency braking and rapid downshifting.
- Ride carefully.

### Brake

Follow the following guidelines:

- Avoid excessive emergency braking and downshifting
  - ▶ Sudden braking will reduce the stability of the motorcycle.
  - ▶ Slow down before turning, or you may slip.
- Be careful when driving on slippery roads
  - ▶ Tyres are easier to slide on slippery surfaces and require longer braking distances.
- Avoid continuous braking
  - ▶ In the long and steep slope down the slope, repeated braking will lead to serious overheating of the brake, affecting the braking effect. You should use the engine brake and use the brake intermittently to slow down.
- The front and rear brakes can be used at the same time to achieve a complete braking effect.

### ■ Engine brake

When you release the throttle, the engine brake will help the motorcycle slow down. If you want to slow down in a further degree, you can downshift to a low gear. When descending a long and steep slope, the engine should be braked and the brake should be used intermittently to slow down.

### ■ A humid and rainy environment

In a wet and rainy environment, the road surface will be wet and slippery, and the wet brake will also reduce the braking efficiency. You need to be very careful when braking. If the brake is wet, it can be intermittently repeated during low-speed driving and riding, which helps to dry the brake quickly.

## Parking

- Stay on solid, flat ground.

If you must stop on a slightly inclined or loose ground, make sure to stop the motorcycle and make sure that the motorcycle cannot move or tip over.

- Ensure that high temperature parts do not come into contact with flammable materials.
- Do not touch the engine, muffler, brake and other high temperature parts before cooling.
- To avoid the possibility of theft, be sure to lock the steering handle and remove the key before leaving the unattended motorcycle.

### ■ Stop the motorcycle with the side support

1. Extinguish engine.
2. Lower side support.
3. Tilt the motorcycle slowly to the left until its weight is concentrated on the side bracket.
4. Turn the steering handle completely to the left.
  - ▶ If the steering handle is turned to the right, it will reduce stability and may cause the motorcycle to fall.
5. Turn the ignition switch to the “” (lock) position and remove the key.

### Fueling/brake fluid and fuel guide

Follow these guidelines to protect your engine and catalytic converter:

- Use only unleaded gasoline.
- It is recommended to use high octane gasoline. The use of low octane gasoline will reduce the performance of the engine.
- It is not recommended to use ethanol gasoline, which will reduce the performance of the engine.
- Do not use spoiled or contaminated gasoline, or oil-gasoline blends.
- Prevent dirt and water from entering the tank.
- Since the brake fluid has a certain corrosive effect, be sure to avoid splashing into the eyes, adhering to the skin and avoiding contact with

nonmetallic materials of the vehicle when adding.

## Spare parts and modifications

We strongly recommend that you do not use any accessories other than KOVEMOTO, and do not modify the original design of the motorcycle, which will cause the motorcycle to be unsafe. Unauthorized modifications to your motorcycle will void your warranty service and result in your motorcycle being unable to legally drive on public roads and highways. Before you decide to add accessories to your motorcycle, first determine which modifications are safe and legal.

**It is prohibited to attach a trailer or a sidecar to a motorcycle and to modify or install other equipment at the engine installation point. Your motorcycle does not have the design of these accessories, and their use will seriously damage the maneuverability and safety of the motorcycle.**

### ⚠Warning

- Improper accessories or modifications may cause safety accidents, in which you may be seriously injured or even life-threatening.
- Please follow all instructions in the Instruction Manual for accessories and modifications.

## Loading guide

- The additional load will affect the maneuverability, braking and stability of the motorcycle. When riding with heavy loads, be sure to maintain a safe speed.
- Please keep within the specified loading limit, the maximum payload of the whole vehicle is 75kg, do not overload.
- Fix all luggage and place it evenly and smoothly near the center of the motorcycle.
- Do not place objects in the headlights or Mufflers.

### ⚠Warning

- Overloading or improper loading will lead to accidents, resulting in serious casualties.

---

• Please follow the loading instructions in the Instruction Manual.

## User Manual

This section contains important information about the operation of the motorcycle, please read this section carefully.

Component Location Diagram.....	14
Switches.....	16
Starting the Engine.....	21
Shifting Gears.....	22
Quick Shift.....	23
Refueling.....	24

Component location diagram

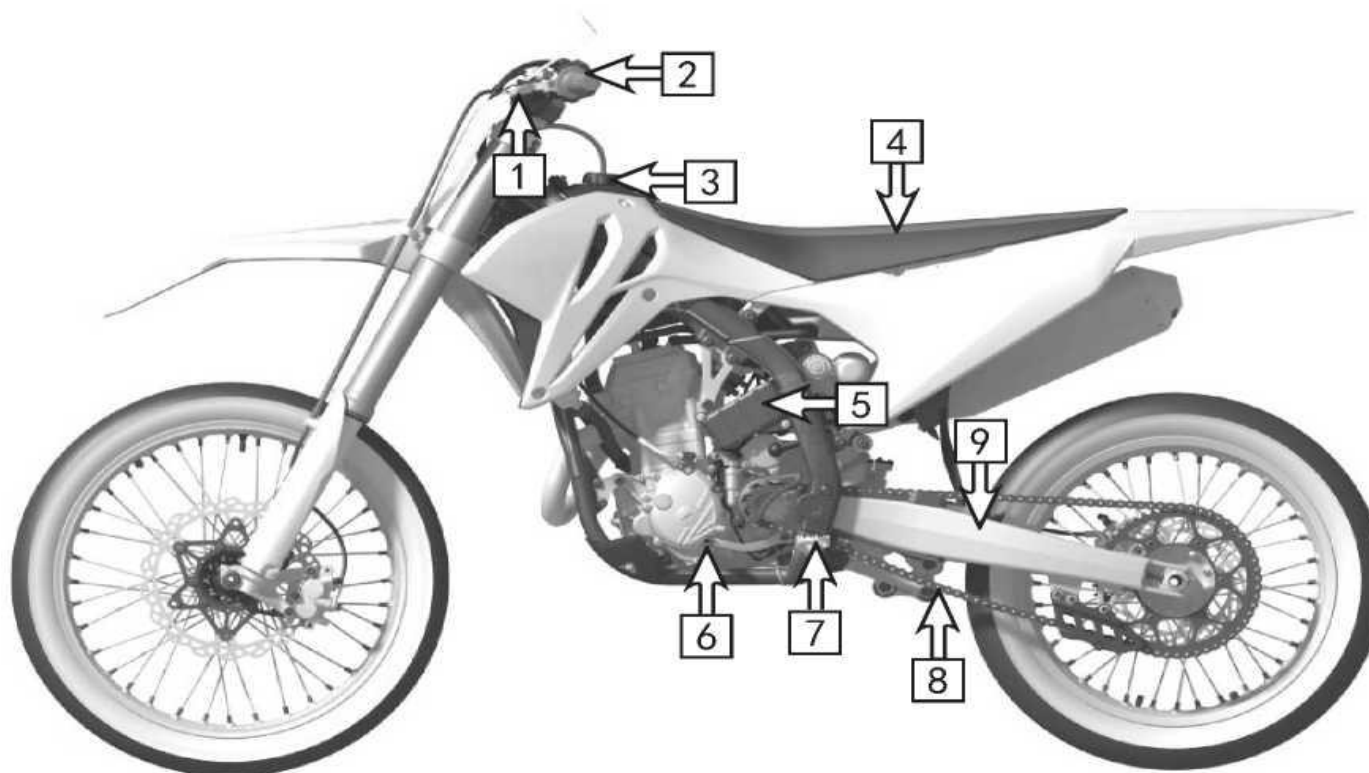

1. Clutch Lever 2. Left combination switch 3. Fuel Tank Cap 4. Seat cushion assembly  
5. Battery 6. Shift Pedal 7. Left Front Footrest 8. Chain 9. Swingarm

### Component location diagram

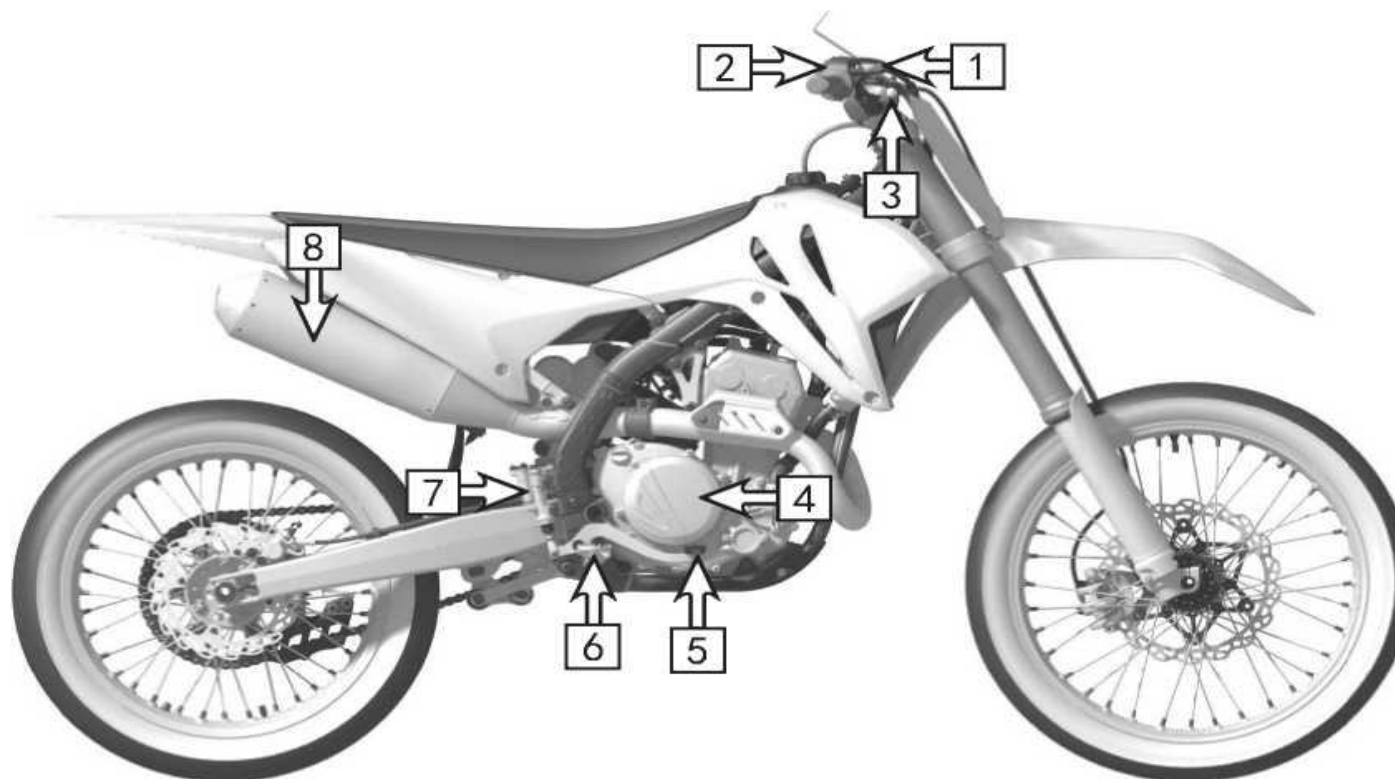

1. Front brake fluid reservoir 2. Right combination switch 3. Front brake lever 4. Engine

5. Rear brake pedal 6. Right footrest 7. Rear brake pump 8. Muffler

## Switch - Field Edition

### Left Handlebar Switch - Field Edition

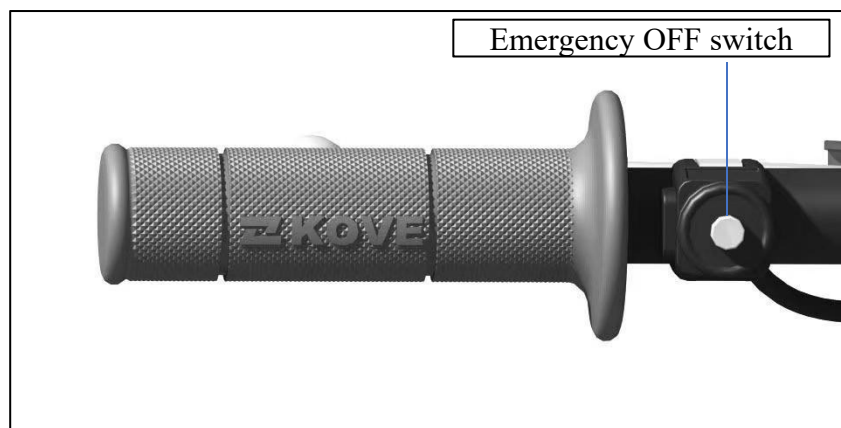

#### **Emergency OFF switch:**

The OFF switch button is located on the left side of the steering handlebar.

Press the OFF switch button to disconnect the ignition circuit and stop the running engine.

### Right Handlebar Switch - Field Edition



#### **Electric Start Switch:**

1. The electric start button is located on the right side of the steering handlebar.
2. Pressing this button will start the engine.

#### **If the engine fails to start:**

If the engine does not start within 3 seconds, please wait for 10 seconds and then press the electric start switch button again.

#### Notes

- Prolonged high-speed idling and neutral revving can damage the engine and exhaust system.
- Sudden acceleration or prolonged idling at high speed for more than 5 minutes may cause the exhaust pipe to discolor.
- If the throttle is fully open, the engine will not start.
- If the gear is not in neutral at startup, hold the clutch lever.

## Switch - Factory Team Edition

### Left Handlebar Switch - Factory Team Edition

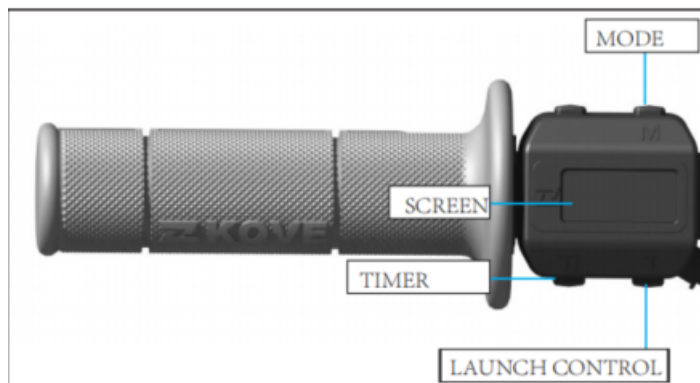

#### Launch Control:

When the launch function is activated, even with the throttle fully open, the throttle speed is limited to 8000 rpm.

After starting the vehicle, press and hold the launch control button for 3 seconds to activate both the launch control and quick shift functions. The indicator light on the display will remain lit, enabling you to perform launch control and quick shifting. When the gear is in 2nd or lower, the launch control and quick shift functions automatically operate; when the gear is higher than 2nd, the launch control and quick shift functions are automatically deactivated.

#### Mode Button:

Press the mode button once to activate SPORT mode, and the "S" indicator on the display will remain lit. Press it again to switch to ECO mode, and the "E" indicator will remain lit.

#### Timer Button:

The screen defaults to the single-timer interface upon powering on.

Click the timer button: On the single-timer display interface, click the timer button to start the timer, and click again to pause at the current time. Click the timer button to start the timer; click again to pause and read the time; click once more to resume timing.

Clicking on both the total time interface and the single time interface can pause the timer.

Long press (1s): Used to toggle between the single timer and total timer interfaces.

Long press (3s): Resets the single timer. Long pressing on the total time interface will return to the single timer interface and reset it.

Left Handlebar Switch - Display - Factory Team Edition

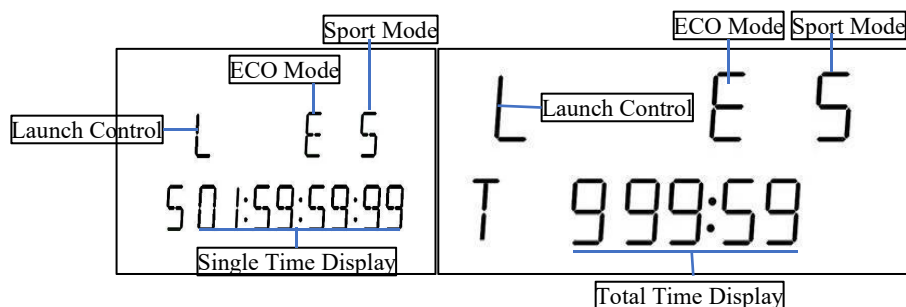

**Single Time Display:**

- The format is <S (single time) hours:minutes:seconds:milliseconds>

**Total Time Display:**

- The format is <T (total time) hours (three digits): minutes>

Total time: The cumulative upper limit is 999 hours and 59 minutes, and it stops at 999:59.

The total time and single timing are independent of each other. The total timing starts when the screen is powered on and is recorded every minute when powered off. If the duration is less than one minute when powered off, it is directly ignored and not counted in the total minutes.

Once the vehicle is started, the display screen begins to operate:

**Launch Control:**

- Launch control activation: Press and hold the button for 3 seconds. While holding, the "L" icon on the display will flash once per second until the 3-second duration ends, at which point the "L" icon will illuminate. The launch control function is now activated.
- Launch control deactivation: When the gear is in 3rd, 4th, or 5th, launch control is automatically deactivated. The "L" icon on the display automatically disappears.
- When the gear is in 1st or 2nd, launch control is enabled, and the button cannot deactivate the launch function.

**Engine Mode (M):**

- Press the switch once to activate SPORT mode, and the display will continuously show the "S" icon.
- Press it again to activate ECO mode, and the display will continuously show the "E" icon.
- This function retains memory of the last operating condition before power-off.

## Right Handlebar Switch - Factory Team Edition

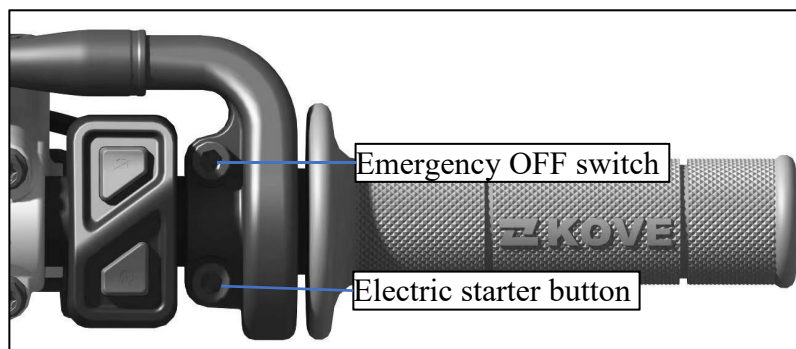
**Switch button:**

When the switch button "⊗" (operate) is pressed, the engine starts;

When the switch button "○" (stop) is pressed, the engine stops working.

## Notes

- To extend the lifespan of the switch, it is recommended to blow out any accumulated water inside the switch after car washing or heavy rain.

## Start the Engine - Factory Team Edition

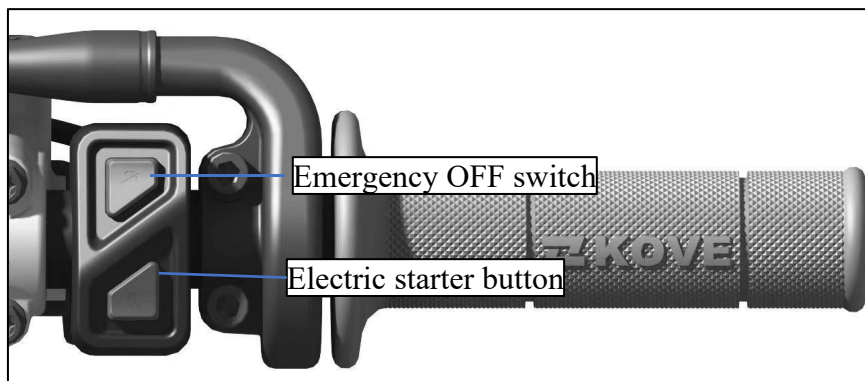

Regardless of whether the engine is cold or hot, please follow the instructions below to start the engine.

1. When the gear is in neutral or not in neutral, firmly squeeze the clutch lever.
2. With the throttle fully closed, press the electric starter button to start the motorcycle.

### **If the engine fails to start:**

If the engine does not start within 3 seconds, wait for 10 seconds before repeating step 4.

### Notes

- If the engine starts but idles unevenly, slightly increase the throttle.
- Prolonged high-speed idling and rotation can harm the engine and exhaust system.
- Sudden acceleration or prolonged idling at high speed for more than 5 minutes may cause the exhaust pipe to discolor.
- If the throttle is fully open, the engine will not start.

## Gear shifting

Your motorcycle features 5 forward gears with a 1-down, 4-up shifting pattern. Gear shifting method:

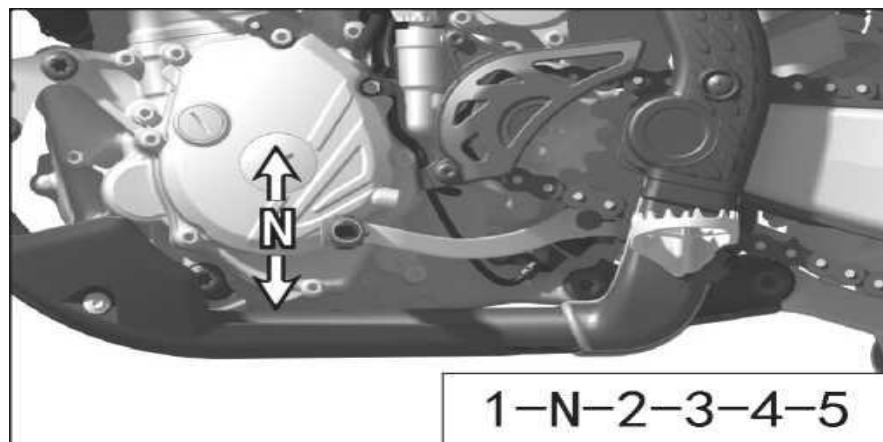

Warm up the engine to ensure smooth operation.

1. When the engine is idling, disengage the clutch and press the gear shift pedal downward to engage the low gear (1st gear).
2. Gradually increase the engine speed while slowly releasing the clutch lever, coordinating these two actions to ensure a smooth start.
3. When the motorcycle reaches a steady riding state, reduce the engine speed, disengage the clutch, and lift the gear shift pedal to engage the 2nd gear, and so on.

### Things to pay attention to while driving:

1. Avoid unnecessary engine idling, and do not allow the engine to idle at high speeds, as this can severely damage the components.
2. Driving with the clutch partially engaged will quickly wear out the clutch plates.
3. If you feel the engine lacks power while climbing a slope, promptly shift to a lower gear.
4. While riding, especially when going downhill or at high speeds, do not use only the front brake or coast in neutral, and do not ride without holding the handlebars.
5. When stopping, reduce the throttle, disengage the clutch at the same time, and then apply the brakes.

### Quick Shift System

The motorcycle is equipped with a quick shift sensor, enabling you to upshift swiftly without using the clutch. As the throttle handle does not need to be closed, you can shift gears seamlessly and continuously.

- ▶ This function will not operate when upshifting with the throttle off.
- ▶ To ensure the proper operation of the quick shift function, when using this feature to shift gears, make sure the shifting action is continuous and complete. Avoid incomplete shifting operations, as the ECU may exit the torque control function, resulting in a failed shift. During daily maintenance, ensure the quick shift sensor remains clean (free of stains, sand, metal shavings, etc.) to maintain proper functionality.

Develop good riding habits during regular rides. After shifting, promptly move your foot to the pedal and avoid placing it above or below the shift lever to prevent accidental shifting. Practice this function regularly to become familiar with its features and fully leverage its capabilities.

## Refueling

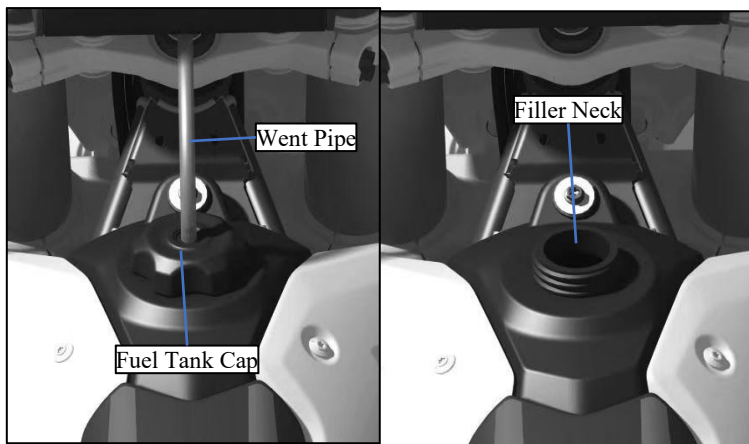

### Open the fuel tank cap:

Rotate counterclockwise.

### Close the fuel tank cap:

Turn the fuel tank cap clockwise to tighten it, making sure the vent pipe does not twist during the process.

### When refueling:

Securely support your motorcycle with a maintenance stand, open the fuel tank cap to refuel, and tighten the cap after filling.

- The fuel tank capacity is 6.5L, and it is recommended to use 95 octane or higher unleaded gasoline.
- Avoid overfilling the fuel tank. Monitor the fuel level during refueling, and it is recommended to fill no more than 90% of the tank's capacity to prevent fuel expansion due to heat.

### ⚠ Warning

- When refueling, always do so outdoors, ensure the engine is turned off, stay away from heat sources, sparks, or open flames, and immediately wipe up any spills.

## Maintenance

Please carefully read the "Maintenance" and "Maintenance Guidelines" sections before preparing for maintenance. Refer to "Technical Parameters" for maintenance data.

Maintenance	26
Maintenance interval table	27
Critical Component Torque Periodic Inspection Checklist	28
Maintenance Guidelines	29
Replacement Parts	30
Removal and Installation of Body Components	37
Engine oil	39
Coolant	41
Brake	43
Drive Chain	46
Clutch	48
Accelerator	49
Front Shock Absorber Adjustment	50
Rear Shock Absorber Adjustment	54

## Maintenance

### The Importance of Maintenance

Always maintain your motorcycle in good condition, as it is essential for your safety, protecting your property, achieving optimal performance, preventing breakdowns, and reducing air pollution.

Maintenance is a crucial responsibility for motorcycle owners. Make sure to perform checks before each ride and conduct regular inspections according to the maintenance interval table.

Please follow these guidelines during maintenance:

- Extinguish engine.
- Park the motorcycle on a firm and level surface using the side stand, or support it with a maintenance stand.
- Wait for the engine, muffler, brakes, and other high-temperature components to cool down before starting operations; otherwise, it may cause burns.
- Start the engine under specified conditions and ensure it is in a well-ventilated environment.

### ▲Warning

- Failure to perform regular maintenance before riding or to properly address faults may result in serious or fatal accidents.
- Please follow the inspection, maintenance recommendations, and maintenance interval table provided in the user manual.

## Component location diagram

The vehicle should be serviced within the specified time frame. To ensure safety, only authorized KOVEMOTO Motorcycle service centers are qualified for the maintenance.

The meanings of the symbols in the table are as follows:

I: Inspect, clean, and adjust R: Replace C: Clean L: Lubrication

Item	Frequency	Notes	Each use for approximately 2.5 hours	Every 3 races for approximately 7.5 hours	Every 6 races for approximately 15 hours	Every 9 races for approximately 22.5 hours	Every 12 races for approximately 30 hours	
Gasoline pipeline		Notes 6	I				R	This maintenance plan is based on average riding conditions. Frequent use of the vehicle requires more frequent maintenance.  <b>Notes:</b> 1. Clean your motorcycle promptly after each ride. 2. Replace every two years and mechanical components are required for replacement. 3. Replace after the first running-in period. 4. Inspect after the first running-in period. 5. Replace the engine oil if the clutch friction plate is replaced. 6. Replace annually. 7. Use genuine parts.
Fuel pump filter element		Notes 6					R	
Accelerator stroke clearance adjustment			I					
Air filter		Notes 1	C					
Crankcase vent pipe			I					
Spark plug			I					
Valve clearance/ Relieve valve		Notes 4			I			
Engine lubricant		Notes 3,5	I		R			
Engine oil filter element		Notes 3			R			
Piston ring					R			
Piston pin					R			
Radiator coolant		Notes 2	I					
Drive chain			I, L	R				
Brake fluid		Notes 2	I					
Brake pad wear			I					
Brake system			I					
Clutch system		Notes 5	I					
Control cable			I, L					
Swingarm/Shock absorber link rod				L				
Front shock absorber oil		Notes 3				R		
Nut and bolt fastener			I					
Wheels/tires			I					
Steering head bearing						I		

### Critical Component Torque Periodic Inspection Checklist

S/N	Name of Fastening Location	Recommended inspection interval
1	Front and rear wheel axle tightening	Torque inspection is required during each maintenance cycle.
2	Upper and lower triple clamps tightening to secure the front shock absorber.	
3	Upper triple clamp and steering stem tightening	
4	Steering stem 8-slot nut tightening	
5	Handlebar lower clamp tightening	
6	Engine sprocket installation tightening	
7	Eccentric wheel tightening	
8	Engine mounting fastening	
9	Rear shock absorber fastening	
10	Front section of muffler with engine	
11	Front and rear brake caliper tightening	
12	Rear brake pump tightening	
13	Shift lever and adjustment rod end bearing tightening	
14	Buffer body and bracket	
15	Cushioning rubber body	
16	Brake pedal and adjusting lever end bearing tightening	
17	Entire brake line tightening	
18	Fuel rail tightening	
19	Fuel pump tightening	During each maintenance cycle inspection or replacement, perform maintenance according to the specified torque and sealing method.
20	Front and rear brake discs tightening	
21		

Note: For torque cycle inspection items not specified in this Instruction Manual, the torque standards shall be followed as per our company's "Maintenance Manual".

## Maintenance Guidelines

To ensure safety, you are responsible for performing a pre-ride inspection and making sure that any issues identified have been resolved. Pre-ride inspection is essential.

Inspection Items	Inspection Details
Handlebar	Smooth and flexible rotation, free from play or looseness
Brake system	Check its operating condition, and inspect the front and rear brake fluid levels and brake pad wear.
Fuel level	Sufficient fuel for the planned journey (refuel if necessary)
Accelerator	Check if it can open smoothly and close completely in all steering positions.
Clutch	Check its operating condition and adjust the free stroke if necessary.
Wheels/tires	Check its usage status and tire pressure, and inflate if necessary.
Drive Chain	Inspect its usage condition and sag, and adjust and lubricate if necessary.
Lighting, horn	Check the lighting system and horn to ensure they are functioning correctly.
Engine oil level	Add engine oil as needed and check for leaks.
Instrument Indicators	Check if all indicators on the instrument panel are functioning properly.

## Replacement Parts

### Battery

#### ■ Inspect and replace the battery.

1. Before installing the battery, if the electrodes are found to be dirty, clean them thoroughly before installation; otherwise, poor contact may lead to malfunction.
2. If during use, the battery exhibits abnormal phenomena such as deformation, overheating, or smoking, stop using it immediately and have it inspected by an authorized KOVEMOTO Motorcycle service center.
3. If the battery is stored in a high-temperature or humid environment for an extended period, it may malfunction or experience a shortened lifespan. Before reuse, ensure the battery's appearance and functionality are normal.
4. If the vehicle fails to start, check whether the battery is functioning properly. If the battery is damaged, replace it immediately.
5. When installing the battery, ensure the battery terminal bolts are securely tightened.

#### **If the battery is not used for an extended period, please note the following:**

- To prevent over-discharge, the battery should be charged every two months.
- When the battery is not in use, it should be stored in a cool, dry environment, and the positive and negative terminals should be protected from short-circuiting.

#### Notes

- Improper handling of batteries may harm the environment and human health. Please dispose of used batteries in accordance with local environmental regulations.
- The addition of electrical appliances may cause battery drain and even electrical system malfunction.

## Fuse

Fuses protect your motorcycle's electrical circuits. If any electrical components of your motorcycle stop functioning, inspect and replace the blown fuse.

### ■ Inspect and replace the fuses

Turn the ignition switch to the "⊗" (off) position, then remove and inspect the fuse. If the fuse is blown, replace it with a fuse of the same specification. Refer to the "Technical Parameters" section for the fuse Parameters.

If the fuse blows frequently, there may be a hidden issue with the electrical system. Please have it inspected by a authorized KOVEMOTO Motorcycle service center.

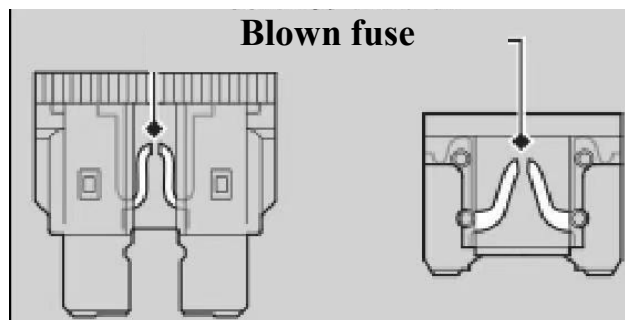

### Notes

- Fuses must be replaced with ones of the same rating. Using a fuse with a higher rating increases the risk of damaging the electrical system and may pose a fire hazard.
- Installing non-KEVOMOTO electrical accessories can overload the electrical system, lead to battery discharge, and even damage the system.

### Engine oil

Engine oil consumption and degradation vary depending on riding conditions and usage duration. The higher the engine speed, the faster the oil consumption rate. When operating at high speeds or high RPM for extended periods, shorten the oil change interval. Regularly check the engine oil level and add the recommended engine oil if necessary. When used in extreme temperatures, oil degrades more rapidly. Dirty or aged oil should be replaced promptly.

### Brake fluid

Do not add or replace brake fluid except in an emergency.

Only use brake fluid that has been freshly taken from a sealed container. If you have added brake fluid, please have the brake system inspected by an authorized KOVEMOTO Motorcycle service center as soon as possible.

### Coolant

Only use the original undiluted KEVO Motorcycle pre-mixed coolant, which offers superior protection against corrosion and overheating. Regularly check the coolant level and promptly add more if it falls below the minimum mark. The coolant has a freezing point of -40°C and a boiling point of 110°C.

## ■ Choosing Engine Oil

The engine oil should be of API classification SN grade or above, with the specification SN10W-40.

### Notes

- Brake fluid can damage plastic and painted surfaces. If spilled, wipe it off immediately and clean thoroughly.
- Recommended brake fluid: DOT4 or equivalent.
- Use coolant specifically designed for non-aluminum engines, as ordinary tap water or mineral water can cause corrosion.

## Drive Chain

The drive chain must be regularly inspected and lubricated. If frequently ridden on poor road surfaces, at high speeds, or with repeated rapid acceleration, the chain should be checked more often.

If the drive chain does not operate smoothly, produces unusual noises, has damaged rollers or loose pins, or missing or bent seals, have the chain inspected by an authorized KOVEMOTO Motorcycle service center.

Also inspect the drive sprocket and driven sprocket. If either shows wear or damaged teeth, have them replaced by an authorized KOVEMOTO Motorcycle service center.

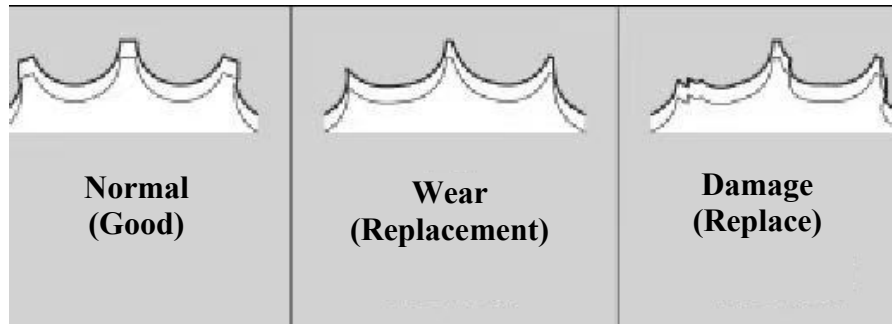

## Cleaning and Lubricating

After checking the sag, clean the chain and sprockets while rotating the rear wheel using a dry cloth, a chain cleaner for sealed chains, or a neutral detergent. If the chain is dirty, use a soft brush. After cleaning, dry it and lubricate with the recommended chain oil.

Avoid using steam cleaners, high-pressure cleaners, wire brushes, volatile solvents like gasoline and benzene, scrubbing agents, chain cleaners, and lubricants that are not specifically designed for oil-sealed chains, as they may damage the chain oil seals.

Avoid getting lubricant on the brakes or tires, and refrain from using excessive lubricant to prevent it from splashing onto clothing or the motorcycle.

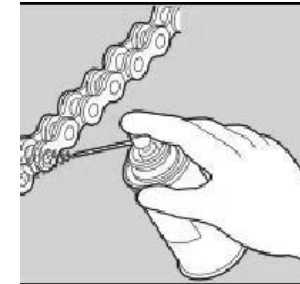

## Notes

- Using a new drive chain on worn sprockets will accelerate chain wear; both the drive chain and sprockets should be replaced simultaneously.
- Recommended lubricant: Specialized lubricant for chain oil seals.

## Tire (Inspection/Replacement)

### ■ Tire specifications

Front tire: 80/100-21

Rear tire: 100/90-19

### ■ Abnormal wear check

Inspect the tire's contact surface for any signs of abnormal wear.

### ■ Inspect the tread depth

Check the tread wear indicator marks; if the wear reaches the indicators, replace the tire immediately.

### ■ Check the tire pressure

When you feel the tire pressure is low, measure it with a pressure gauge. Check the tire pressure when the tires are cool, and do this at least once a month. Ensure the valve core cap is securely tightened; replace it with a new one if necessary.

The standard tire pressure is: Front tire: 110 kPa; Rear tire: 110 kPa.

### ■ Check the damage

Inspect the tires for cuts, cracks, exposed fabric, tire cords, nails, or other foreign matters embedded in the sidewall tread, and also check for any abnormal bulges or swelling on the tire sidewall.

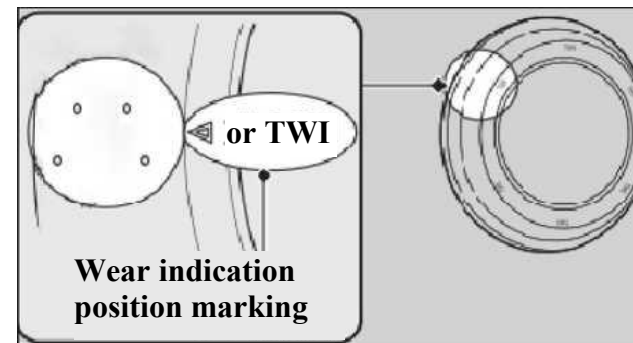

**Whenever replacing tires, follow these guidelines:**

- Use the recommended tires or equivalent products with the same size, structure, speed rating, and load capacity.
- After installing the tires, use the original KOVEMOTO motorcycle wheel balancer or equivalent equipment to balance and align the wheels.

**▲Warning**

- Using excessively worn or improperly inflated tires can lead to accidents, resulting in serious injuries or fatalities. Please follow the relevant tire inflation and maintenance guidelines provided in the Instruction Manual.
- Installing unsuitable tires can impair handling and stability, potentially causing accidents and even endangering lives.
- Always use the tire size and type recommended in this Instruction Manual.

## Air filter

This motorcycle is equipped with a sponge air filter element. Do not perform maintenance yourself. It should be cleaned or replaced by an authorized KOVEMOTO Motorcycle service center.

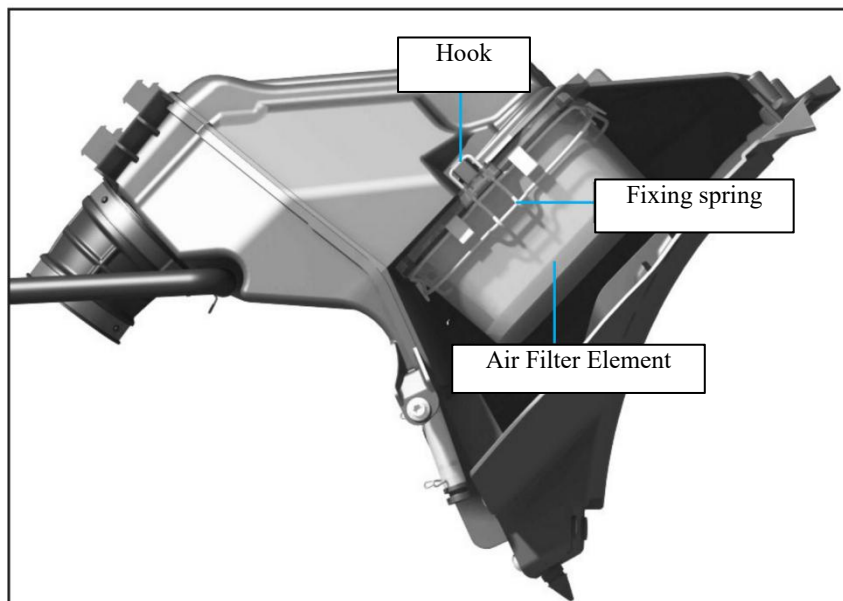

### Removing the air filter element:

1. Park the motorcycle on a stable, level surface and remove the seat assembly.
2. Open the air filter cover plate.
3. Unhook the spring securing the air filter element and remove the air filter element.
4. Apply air filter oil evenly around the cleaned or new air filter element and reinstall it onto the air filter.

Note: The installation sequence is reversed from the removal sequence.

### Clean the air filter element:

Add an appropriate amount of neutral detergent to clean water and thoroughly wash the air filter element, ensuring there is no dirt or dust. Clean again if necessary.

## Removal and Installation of Body Components

### Battery

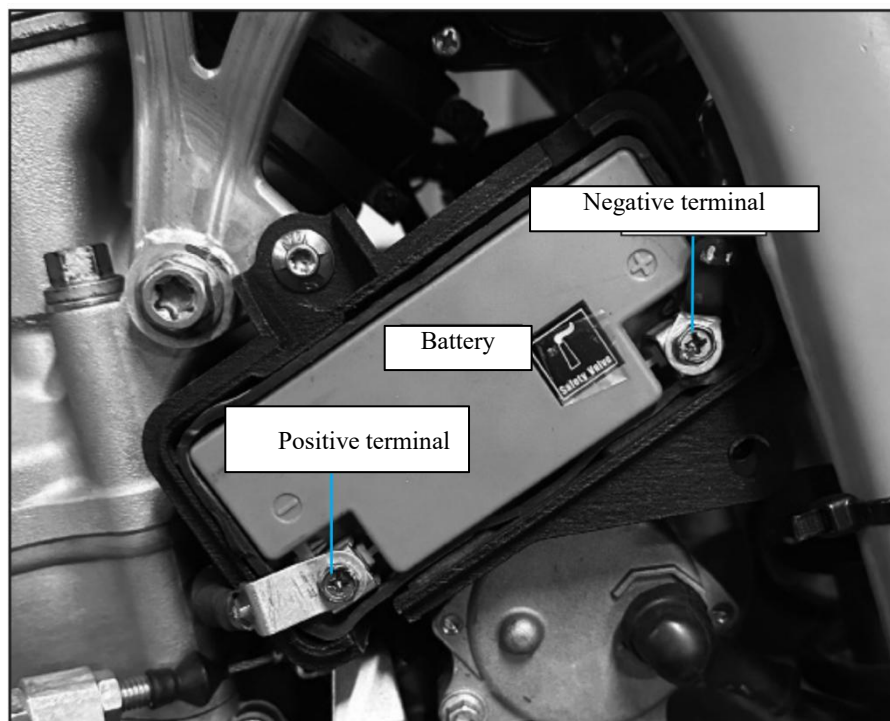

#### ■ Disassembly

Make sure the ignition switch is turned to the "⊗" (off) position.

1. Remove the seat cushion.
2. Release the rubber strap from the back.
3. Disconnect the negative (-) terminal of the battery.
4. Disconnect the positive (+) terminal of the battery.
5. Remove the battery, being careful not to leave the bolts and nuts.

#### ■ Installation

Install all parts in the reverse order of removal, ensuring to connect the positive terminal (+) first and the negative terminal (-) last; ensure that the bolts and nuts are tightened.

## Seat Cushion

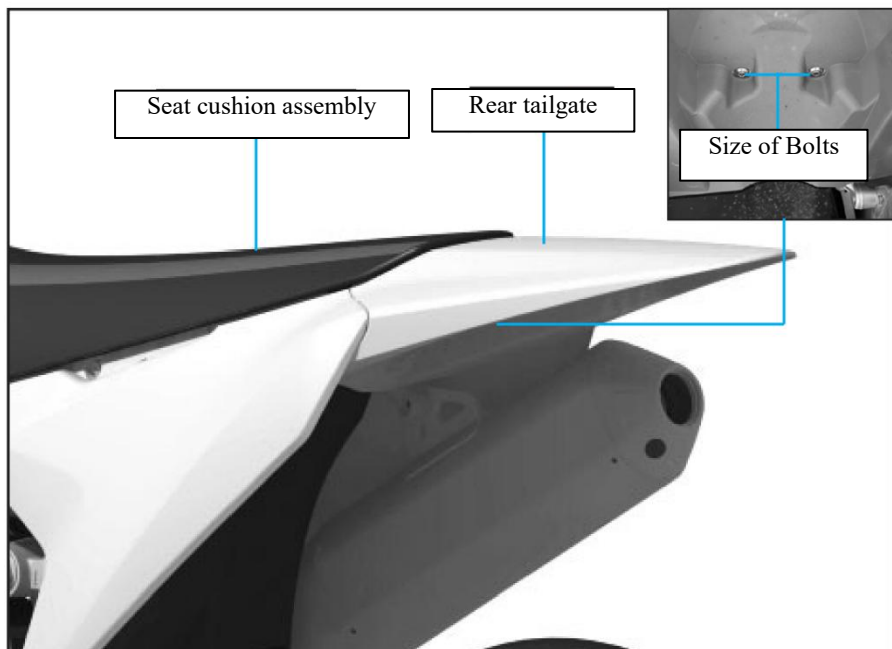

### ■ Disassembly

1. Remove the two bolts connecting the rear of the seat cushion to the rear tailgate.
2. Lift the rear end of the seat cushion diagonally upward and remove it with a slight force.

### ■ Installation

1. Insert the front and rear pins of the seat assembly into the frame slot respectively.
2. Install the bolts, torque: 8N·m.
3. Gently lift the seat cushion upward to ensure it is securely installed.

### Notes

- Ensure the seat pin is securely inserted into the frame slot; otherwise, the seat may not support your weight and could be damaged.

## Engine oil

### Inspect and top up engine oil

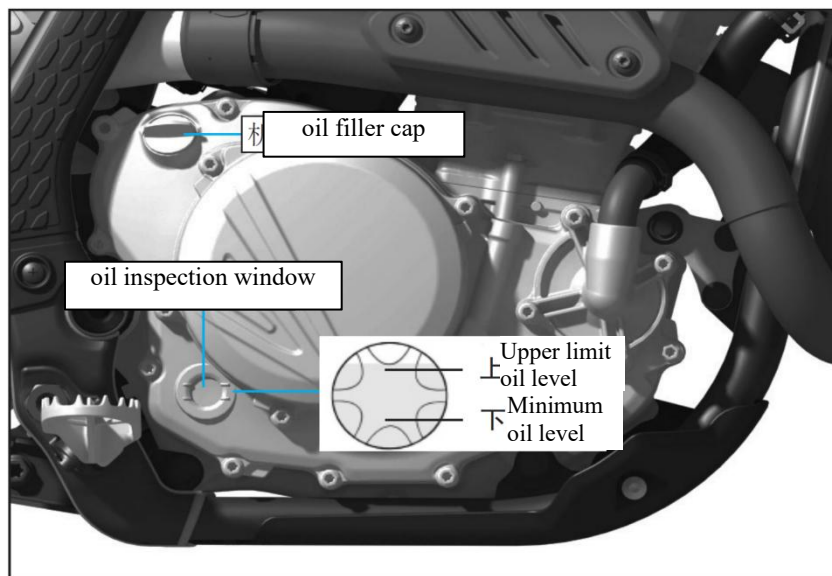

### Check the engine oil

1. Let the engine idle for 3 - 5 minutes, turn the ignition switch to the “” (OFF) position, and then wait for 2 - 3 minutes.
2. Place the motorcycle upright on a stable and flat surface, remove the left windshield, take off the oil filler cap, and check the oil level on the front grid scale of the inspection port cover to ensure it is between the upper and lower marks.

### Add the engine oil

When the engine oil level is below or close to the lower limit mark, add the recommended engine oil.

1. Remove the engine oil filler cap, add the recommended oil to the mark of the oil level. Do not exceed the upper limit mark, and ensure that no foreign matters enter the engine oil filler. If there is any spillage, wipe it off immediately.
2. Reinstall and tighten the engine oil filler cap.

### Notes

- Long-term skin contact with oil shall be avoided. Wash thoroughly after contact with oil.
- Overfilling or underfilling the oil will damage the engine. Do not mix oils of different brands and grades, as this will affect lubrication and clutch operation.
- The used engine oil and container are harmful to health and the environment. They cannot be disposed of as household waste and should be handled in accordance with local environmental regulations.

## Replace the engine oil and the oil strainer

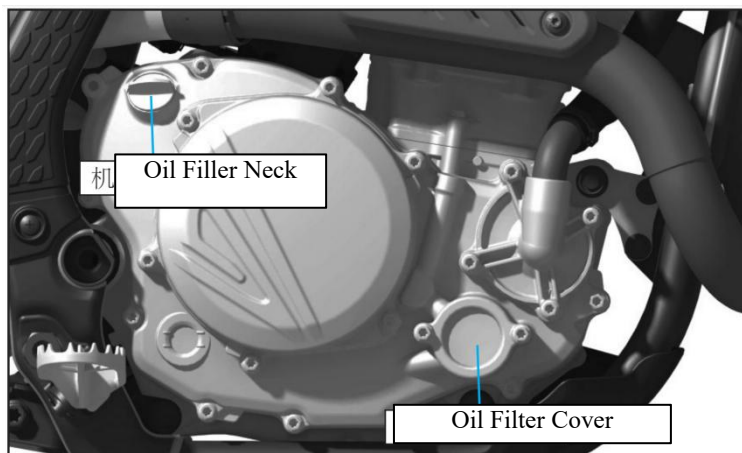

### Replace the engine oil and the oil strainer

Special tools are required to replace the engine oil and the oil strainer. We recommend that the inspection and maintenance be completed by an authorized KOVEMOTO Motorcycle service center. Please refer to the "Maintenance Interval Table" for the maintenance interval of engine oil and secondary oil filter.

1. If the engine is cold, please idle for 3-5 minutes, turn the ignition switch to the "⊗" (OFF) position, and then wait for another 2-3 minutes.
2. Park the motorcycle on a stable, level surface and place an oil drain pan beneath the drain bolt.

3. Remove the lower protector, oil filler cap, drain bolt, and sealing washer, and drain the oil until it drips.
4. Remove the oil filter cap, take out the filter, and drain the remaining oil.
5. Replace the oil filter with a new one, install a new sealing washer on the oil filter cap, apply grease to the sealing washer, and securely install the oil filter cap (torque: 11–13 N·m).
6. Install a new sealing washer on the oil drain bolt and tighten the oil drain bolt (torque: 24 N·m).
7. Add the recommended genuine engine oil to the crankcase. After refilling, tighten the oil filler cap (torque: 11–13 N·m).
8. Check the engine oil for leakage.

**When replacing the oil fine filter, the required oil volume is 1.1L.**

**When replacing the oil fine filter and coarse filter strainer, the required oil volume is 1.2L.**

**When reassembling after disassembling the engine, the required oil level: 1.35 L**

#### Notes

- Using the wrong engine oil and oil filter strainer can seriously damage the engine.
- Dispose of the engine oil and oil filter strainer at the appropriate recycling center.
- Use the specified KOVEMOTO original engine oil and oil filter strainer.

## Coolant

### Inspect the coolant level

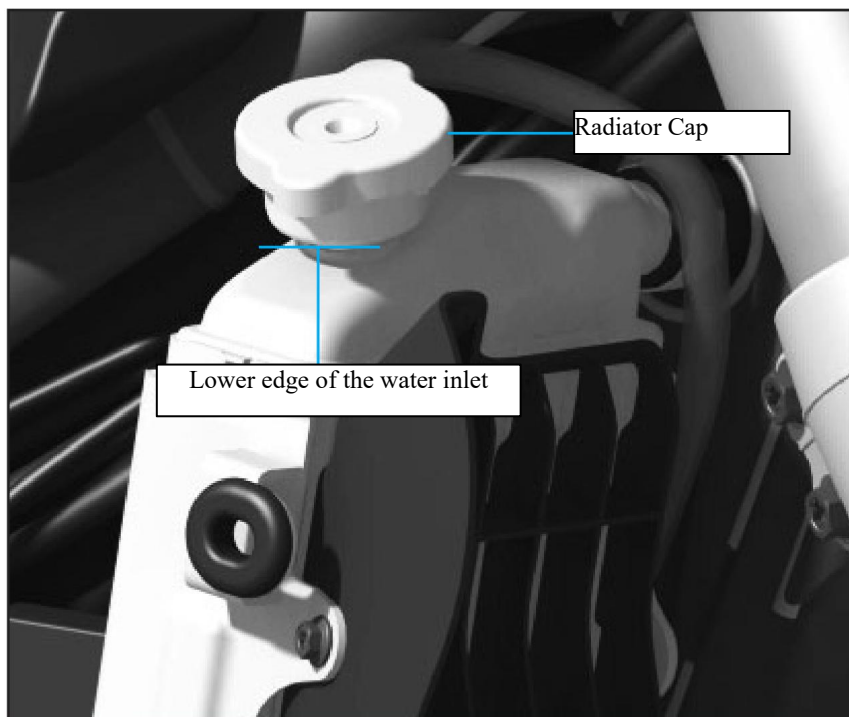

Check the coolant level in the reservoir when the engine is cool.

1. Park the motorcycle on a firm and flat level.
2. Keep the motorcycle upright.
3. Remove the radiator cap and check the coolant level from the water inlet. The coolant level should be at the lower edge of the water inlet.
4. If the coolant level drops significantly or the reservoir is empty, there may be a serious leak. Please have it inspected by an authorized KOVEMOTO Motorcycle service center.

### Add coolant

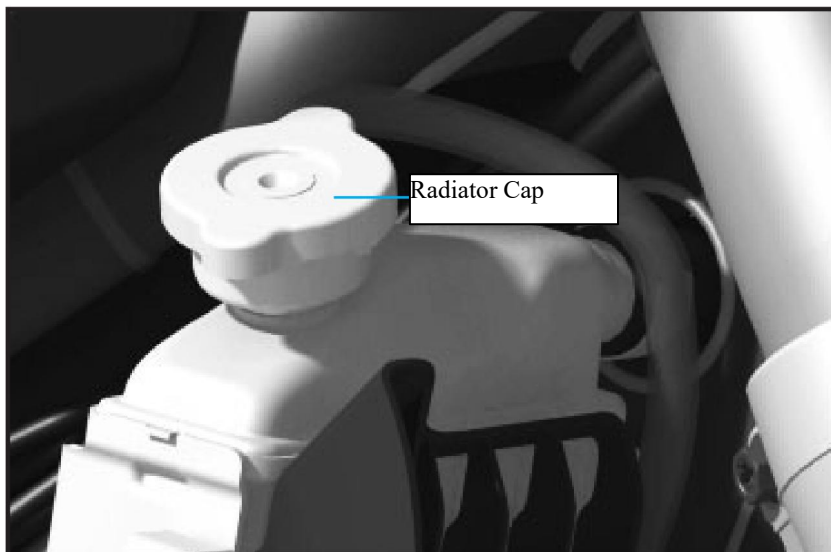

If the coolant level is low, add the recommended coolant up to the water inlet.

When adding coolant, open the radiator cap while the engine is cool and add it through the filler port. Ensure that no foreign matters enter the water inlet during the process. After completing the addition, reinstall the radiator cap.

#### **⚠ Warning**

- Do not remove the radiator cap while the engine is still hot, as this may cause the coolant to spray out and potentially cause burns.

### Replace the coolant

Unless you possess the appropriate tools and qualified mechanical skills, please entrust the coolant replacement to the authorized KOVEMOTO Motorcycle service center.

## Brake

### Inspect the brake fluid.

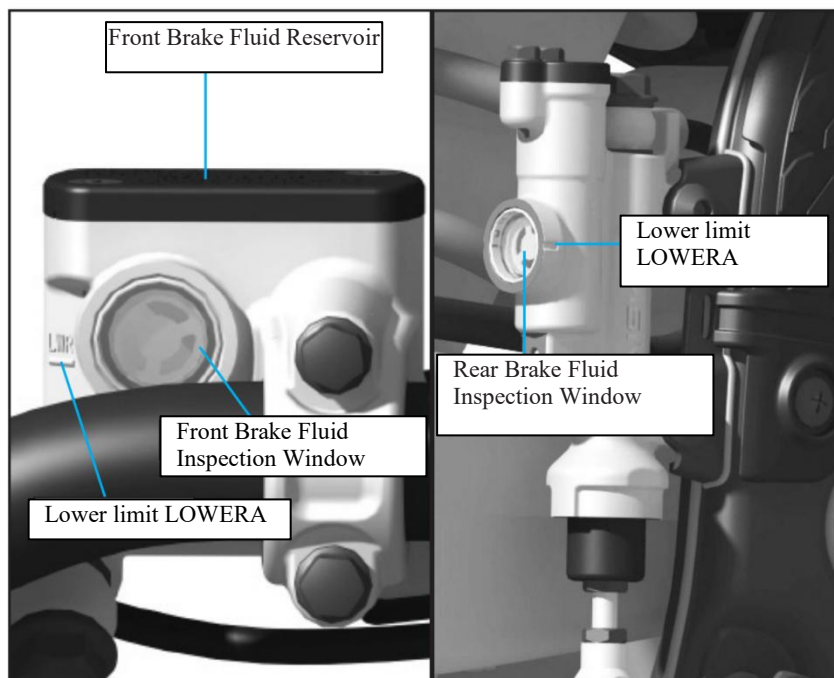

1. Place the motorcycle vertically on a firm and flat ground.
2. Check if the front and rear brake fluid reservoirs are horizontal.
3. Check if the brake fluid is visible in the inspection window. If the brake fluid level is below the lower limit of the inspection window, add it immediately.

If the brake fluid level in the oil cup is lower than the lower limit (LOWER) level mark or the free stroke of the brake rod and pedal is out of limit, users must check whether the brake pad is worn. If the brake pad is not worn, there may be leakage. Please have it repaired by an authorized KOVEMOTO Motorcycle service center.

## Add brake fluid

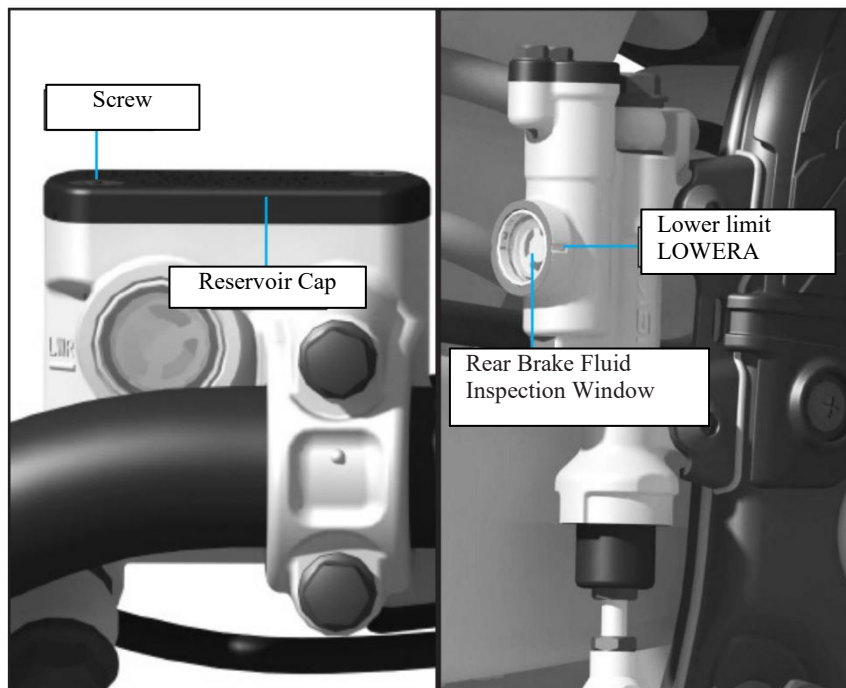

Do not mix different types of brake fluid. Use only brake fluid that has been freshly taken from a sealed container. When adding brake fluid, take care to avoid the entry of foreign objects.

**Recommended brake fluid: DOT4 or equivalent.**

Add brake fluid to the front

1. Remove the screw, reservoir cap, and diaphragm above the front brake fluid reservoir.
2. Add the recommended brake fluid to the front brake fluid reservoir above the minimum level.
3. After adding, install the diaphragm and reservoir cap.
4. Tighten the screw to a torque of 1N·m.
5. Check for any leaks.

**Add rear brake fluid.**

1. Remove the screw, cap, gasket, and diaphragm above the rear brake fluid reservoir.
2. Add the recommended brake fluid to the rear brake fluid reservoir, ensuring it is above the lower limit.
3. After installation, attach the diaphragm, gasket, and tank cover.
4. Tighten the screw to a torque of 1N·m.
5. Check for any leaks.

### Notes

- Brake fluid can damage plastic and painted surfaces. If spilled, wipe it off immediately and clean thoroughly.

**Check the brake pads.**

**Front**

Inspect the brake pad from beneath the brake caliper.

Brake pad lining thickness: 4.7mm (indicator mark indicates the wear limit)

**Rear**

Inspect the brake pad from the right rear of the brake caliper.

Brake pad lining thickness: 4.7mm (indicator mark indicates the wear limit)

If necessary, have the brake pads replaced by an authorized KOVEMOTO Motorcycle service center (when the wear limit is reached, both the left and right brake pads must be replaced simultaneously).

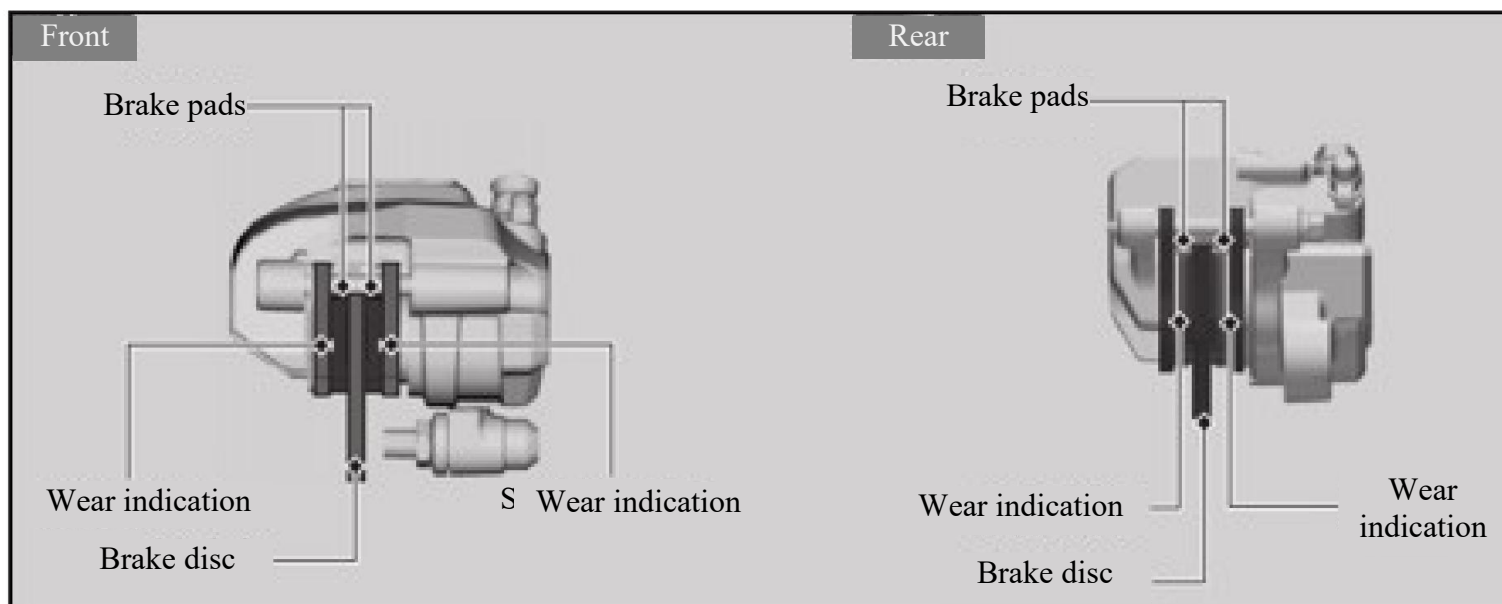

## Drive Chain

### Check the drive chain sag

Check the sag at various points along the chain. If the sag is inconsistent at any point, some links may be bent or kinked. Please have the chain inspected by an authorized KOVEMOTO motorcycle service center.

1. Put the transmission into neutral and turn off the engine.
2. Place the motorcycle vertically on a firm and flat ground.
3. Determine the chain sag by pushing the chain toward the swingarm in the area behind the chain guard.
4. Rotate the rear wheel forward and check if the chain operates smoothly.
5. Inspect the sprocket.
6. Clean and lubricate the drive chain.

Lift the drive chain from the position indicated by arrow 1 and measure the midpoint between the positions indicated by the two arrows.

Drive chain sag: 65-70 mm

If the sag exceeds 75mm, you must not continue riding the motorcycle.

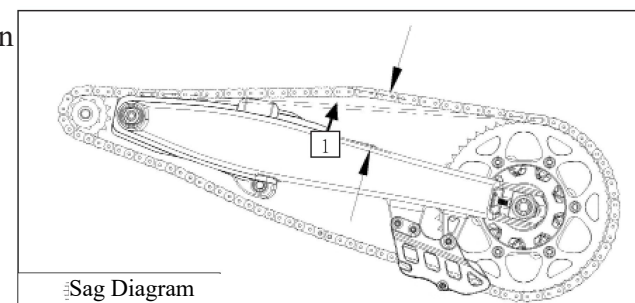

### Notes

- When inspecting the drive chain sag, ensure that the upper section of the chain is properly tensioned.

## Adjust the sag of the drive chain

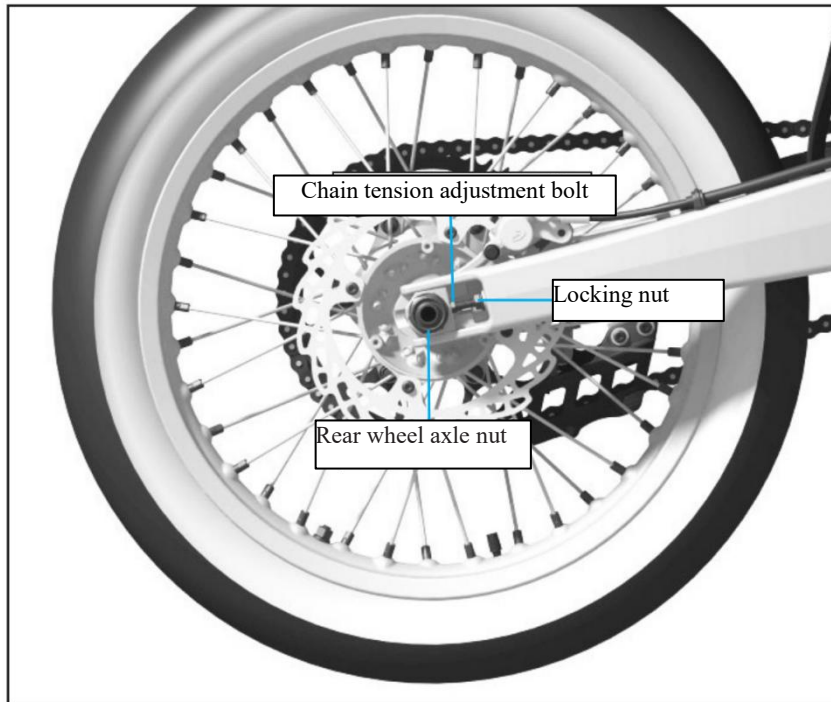

When adjusting the sag of the drive chain:

1. Put the transmission into neutral and turn off the engine.
2. Place the motorcycle vertically on a firm and flat ground.
3. Loosen the rear wheel axle nut.
4. Loosen the locking nut and chain tension adjusting bolt with an open-end wrench.
5. Rotate the chain tension adjustment nut to adjust the chain tension. The chain tension adjustment range is 25-35mm (refer to the sag diagram for details).
6. Push the chain in the direction of the plate fork at the middle of the upper part of the rear plate fork, to determine the reasonable sag of the chain.
7. The sag on both sides should be adjusted to the same scale line.

### Notes

- When adjusting the drive chain sag, ensure that the upper section of the chain is taut.

## Clutch

Clutch lever free stroke: 10-15mm

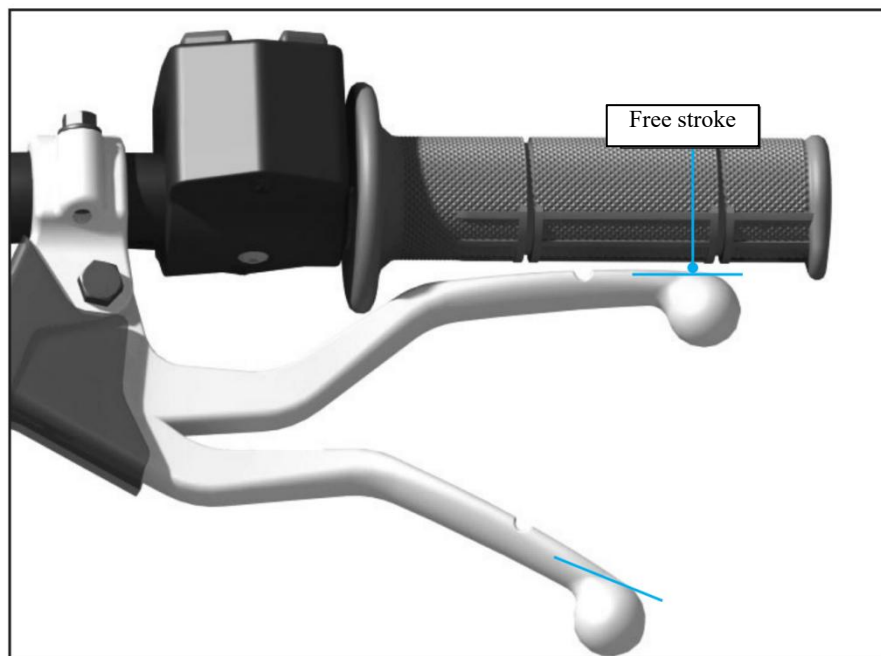

Inspect the clutch cable for any bends or signs of damage. If necessary, have it replaced by an authorized KOVEMOTO motorcycle service center. Lubricate the clutch cable with a dedicated cable lubricant to prevent premature wear and corrosion.

### Notes

- Incorrect adjustment of the free stroke can lead to premature wear of the clutch.

## Accelerator

### Inspect the throttle

With the engine off, check if the throttle moves smoothly in all directions. The position should smoothly transition from fully closed to fully open, with the free stroke being accurate.

If the throttle operation is not smooth, it automatically closes, or the cable is damaged, have it inspected by an authorized KOVEMOTO motorcycle service center.

Free play of the throttle handle flange: 2-6mm

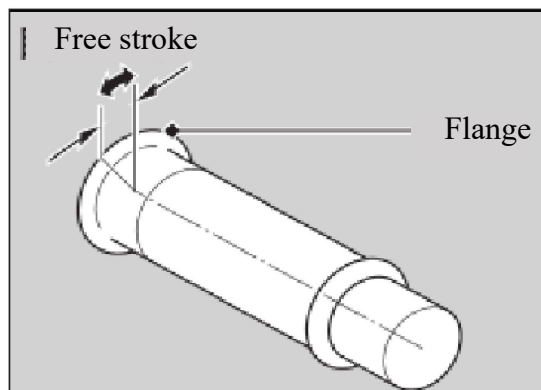

#### Notes

- Do not turn the adjuster beyond its natural limit.

### Adjust the brake handle

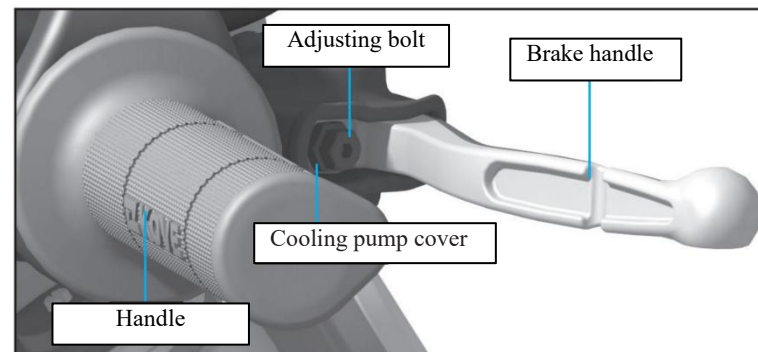

You can adjust the distance between the top of the brake handle and the handlebar grip.

#### ■ Adjustment Method

Remove the brake lever cover, use an 8mm wrench to loosen the lock nut first, rotate the adjustment nut clockwise to move the brake lever away from the handle, and rotate it counterclockwise to move the brake lever closer to the handle. After adjusting, tighten the internal locking nut. After adjustment, check whether the brake handle works correctly before riding.

## Front shock absorber adjustment

### Air pressure adjustment

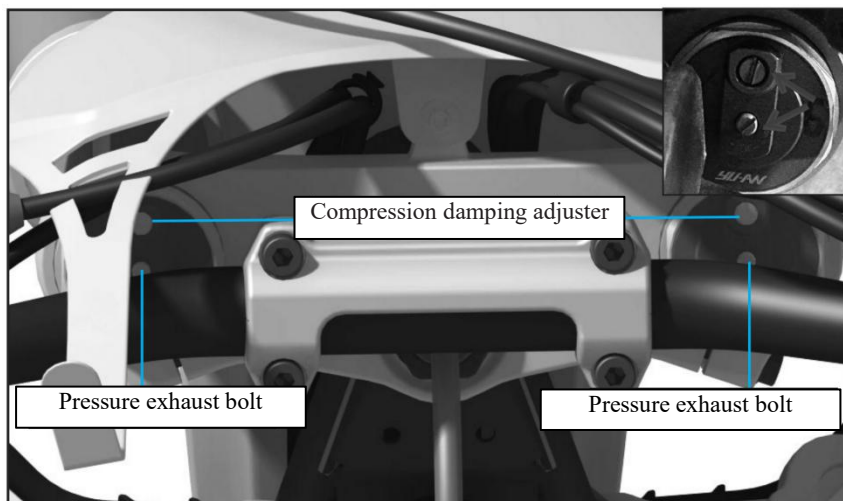

The shock absorber creates internal air pressure during movement, and this air pressure functions like a progressive spring, influencing the motorcycle's entire ride. During a long ride, the front shock absorber will become harder. Therefore, the air pressure in the front shock absorber needs to be released in time.

You can use the pressure exhaust bolt to release the air pressure accumulated in the front shock absorber. Before releasing pressure, make sure that the front tire is off the ground. At this time, the front shock absorber is fully extended.

#### Adjustment method:

1. Place an optional workbench under the engine to lift the front wheels off the ground.
2. Remove the pressure exhaust bolt.
3. Apply No. 2 lithium grease to the O-ring and install it properly.
4. Tighten the pressure exhaust bolt, torque: 1.3 N·m.

#### Notes

- When discharging the air pressure of the front shock absorber, if the O-ring is broken, replace it in time.
- If the air pressure of the front wheels is adjusted on the ground, the wrong pressure degree will be given.

## Inspection of front shock absorber

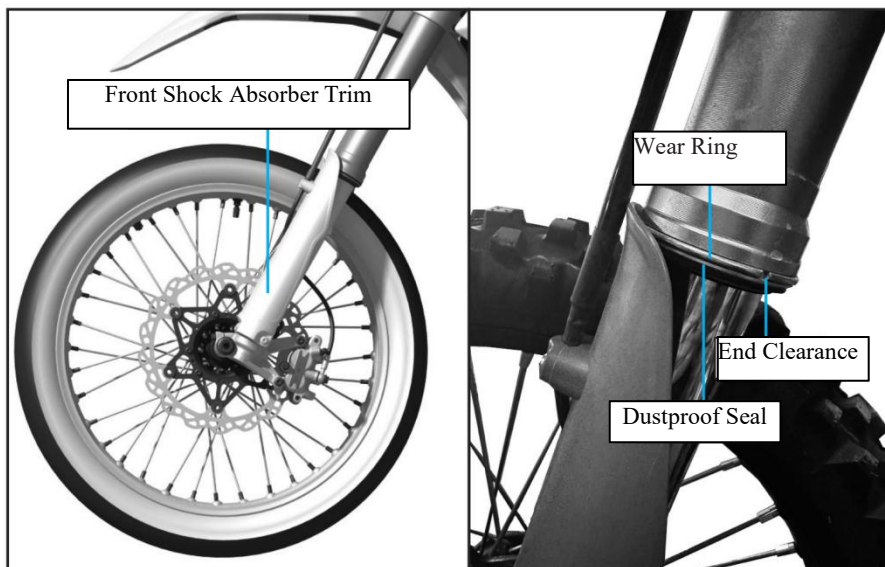

Check and clean all parts of the front shock absorber regularly to ensure optimum performance:

1. Check that the front shock absorber trim and dust seal are clean and that there is no soil or dirt on the front shock absorber.
2. Check for oil stains under the spring strut dust seal. If there are signs of oil leakage, replace the damaged dust seal and oil seal.
3. Check if the wear ring is worn or damaged. If the diameter of the wear ring is less than 1.7mm or flush with the outer cylinder, replace the wear ring. When replacing the wear ring, remove the bottom tube and install the wear ring with its end clearance facing the rear of the vehicle.
4. Pinch the hand brake lever and press the handlebar back and forth several times to check whether the front shock absorber rebounds smoothly.

## Inspection of front shock absorber

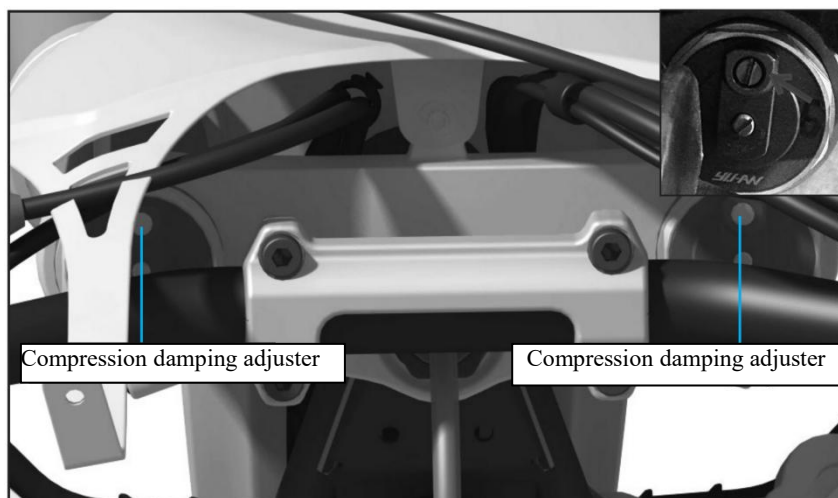

The adjustment of the compression damping affects the speed at which the front shock absorber compresses. The front shock absorber features 22 stages of compression damping. Each segment is a quarter turn. Turning the compression damping adjustment bolt one full turn will rotate the adjuster by 4 segments.

The compression damping gets harder when the adjuster is rotated clockwise (H), and the compression damping gets softer when the adjuster is rotated counterclockwise (S).

### Set standard compression damping:

1. Clockwise rotate the compression damping adjuster until it cannot be rotated.
2. Rotate the adjuster in a counterclockwise direction. The standard compression damping is to rotate 10 segments counterclockwise from the hardest position (the position where a click sound is heard).

You can make adjustments based on your weight and riding conditions. Ensure that the adjustment bolt stops at the click position and both ends are set to the same level after each adjustment.

### Notes

- Do not rotate the adjustment bolt beyond the specified position, as it may damage the adjustment mechanism. The adjusting torque shall not exceed 0.5N·m.

## Rebound damping adjustment



The adjustment of rebound damping will affect the rebound speed of the front shock absorber. The front shock absorber features 22 stages of rebound damping. Each segment is a quarter turn. Rotating the rebound damping adjustment bolt one full turn will advance the adjuster by 4 stages.

Turn the adjustment bolt clockwise (H) to increase the rebound damping (hard), and turn it counterclockwise (S) to decrease the rebound damping (soft).

### Set the standard rebound damping:

1. Rotate the rebound damping adjustment bolt clockwise until it can no longer be turned.
2. Clockwise rotate the rebound damping adjuster until it cannot be rotated.

You can make adjustments based on your weight and riding conditions. Ensure that the adjustment bolt stops at the click position and both ends are set to the same level after each adjustment.

### Notes

- Do not rotate the adjustment bolt beyond the specified position, as it may damage the adjustment mechanism. The adjusting torque shall not exceed 0.5N·m.
- By turning the adjuster clockwise, both compression damping and rebound damping can be

## Rear shock absorber adjustment

### Spring preload adjustment

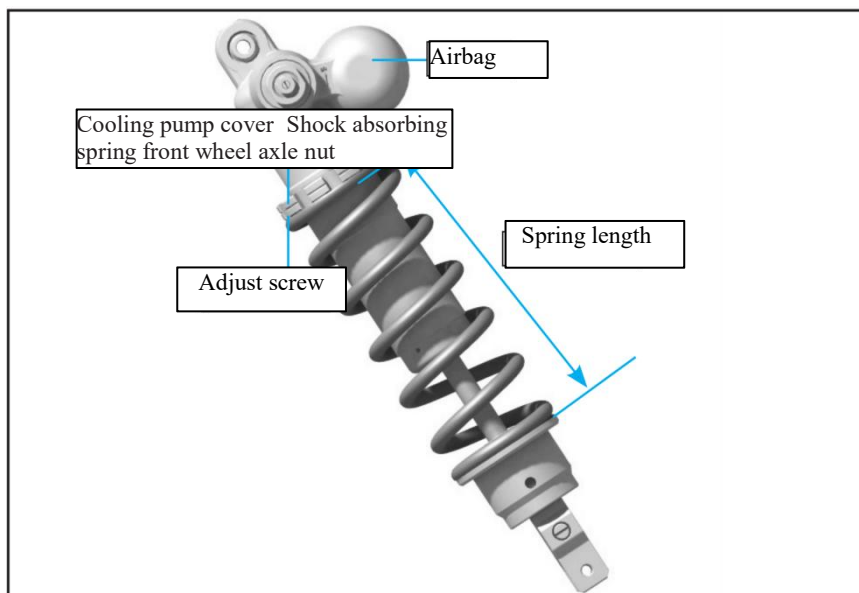

The rear shock absorber assembly includes a shock airbag containing high-pressure nitrogen. Do not attempt to disassemble, repair, or dispose of the device. Piercing or exposing it to flames may cause an explosion, resulting in serious injury. Repair or disposal should be completed by special repair shop of KOVEMOTO.

The spring preload shall be adjusted when the engine is cooled, and the shock absorber spring locking and adjusting nuts shall be rotated to adjust the spring preload.

#### Adjustment method:

1. Securely support your motorcycle with a maintenance bracket or a crane and lift the rear wheels off the ground.
2. Check whether the spring preload is in the standard length.
3. Loosen the shock absorber spring locking nut and rotate the adjusting nut. The spring length will change by 1.5 mm for each turn of the adjusting nut.
4. Make corresponding adjustments as needed.
5. After the adjustment is completed, hold the adjusting nut and tighten the shock absorber spring lock nut (torque:  $44 \pm 3 \text{N} \cdot \text{m}$ ).

## Compression damping adjustment

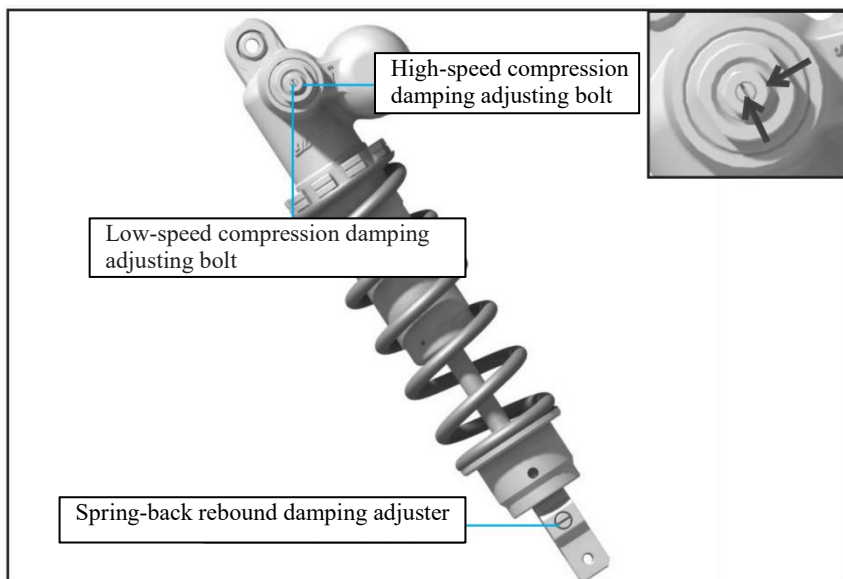

The compression damping can be adjusted separately for the bolt to conduct high-speed compression damping and low-speed compression damping. You can adjust it according to your weight and riding conditions.

When adjusting the compression damping adjustment bolt, always use a tool of the appropriate size to prevent damage.

### High-speed compression damping adjustment

When it is necessary to adjust the compression damping of the shock absorber at high speed, adjust the hexagonal part of the compression damper, and adjust the stroke by about 4 turns. The compression damping increases after clockwise (H) adjustment, and the damping decreases after counterclockwise (S) adjustment. Adjust to the standard position:

1. Rotate the adjuster clockwise (H) until it cannot be rotated.
2. Rotate the adjuster counterclockwise for 2 turns from the hardest position.

## Compression damping adjustment

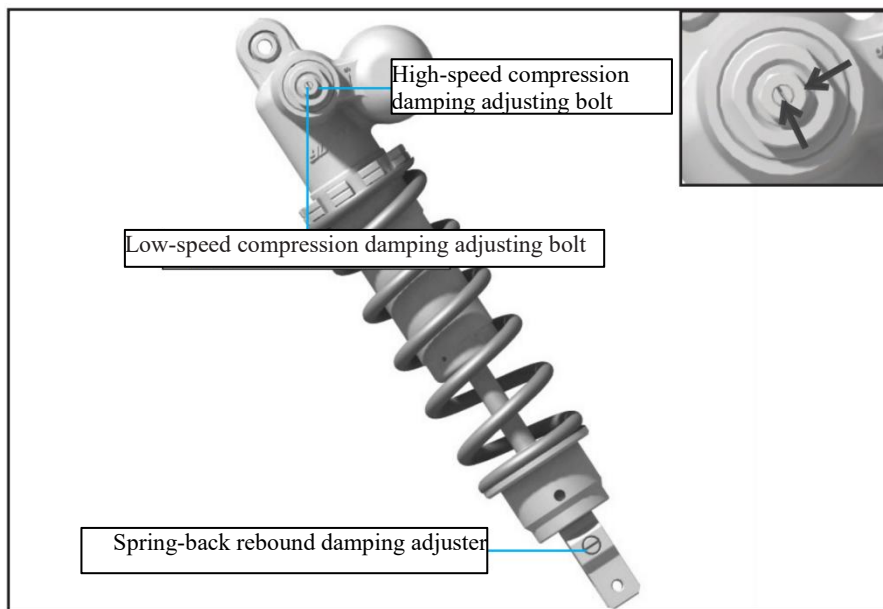

### Low-speed compression damping adjustment

When it is necessary to adjust the compression damping of the shock absorber at high speed, adjust the center slotted bolt part of the compression damper. The adjustment range is 16 segments in total, and each segment is 1/4 circle. The compression damping increases after clockwise (H) adjustment, and the compression damping decreases after counterclockwise (S) adjustment.

Adjust to the standard position:

1. Rotate the adjuster clockwise (H) until it cannot be rotated.
2. Rotate the adjusting bolt for 8 segments counterclockwise from the hardest position (until a click sound is heard).

### Notes

- The torque for low-speed compression damping adjustment must not exceed 0.5 N·m.

## Rebound damping adjustment

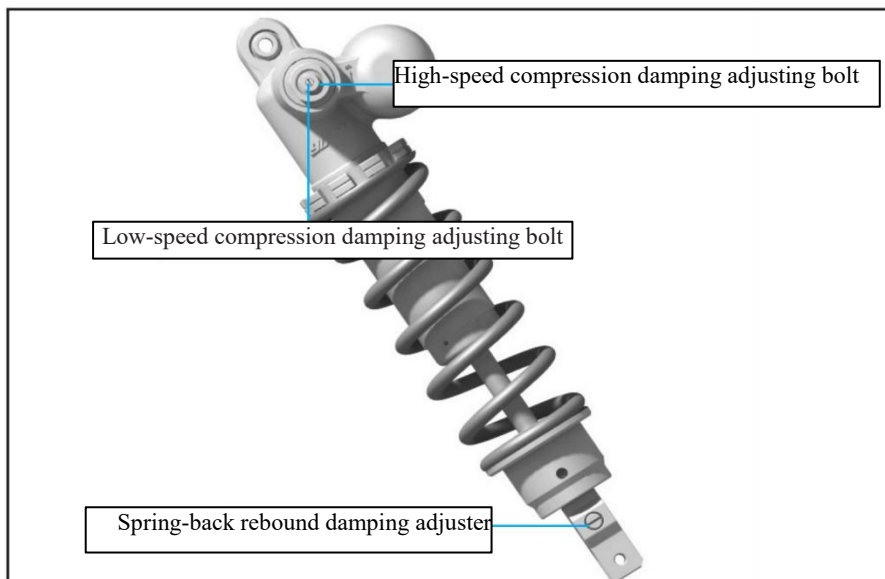

The rebound damping adjuster is located at the left lower end of the rear shock absorber. The rebound damping increases when the adjuster is rotated clockwise(H), and the rebound damping decreases when the adjuster is rotated counterclockwise(S).

### Set the standard rebound damping:

1. Rotate the rebound damping adjusting bolt clockwise (H) until it cannot be rotated.
2. Rotate the adjusting bolt in a counterclockwise(S) direction. The standard rebound damping is to rotate 10 segments counterclockwise from the hardest position (the position where a click sound is heard).

### Notes

- Gently rotate the adjusting bolt to prevent damage to the shock absorber.
- When adjusting the rebound damping adjustment bolt, always use a properly sized tool to prevent damage.
- Make sure that the adjusting bolt is firmly in the fixed position during each adjustment.
- The adjusting torque shall not exceed  $0.5\text{N}\cdot\text{m}$ .

## Fault Handling

Please carefully review the "Maintenance" and "Technical Parameters" sections before servicing. For repair data, refer to the "Technical Parameters."

The engine fails to start. ....	60
Puncture .....	61
Removing the Wheel .....	62
Electrical malfunction .....	66

**The engine fails to start.****The starter motor runs, but the engine fails to start.****Inspect the following items:**

- Verify that the correct engine start sequence is being conducted.
- Check if there is fuel in the tank.
- Check whether the battery voltage is too low.
- Ensure the side stand is retracted when not in neutral.

**The starter motor is not functioning.****Inspect the following items:**

- Inspect the following items:
- Verify that the engine start sequence is correct.
- Ensure that the engine OFF switch is in the operating position.

Check whether the battery voltage is too low, the fuse is blown, or the battery connection is loose. If the problem persists, please have it inspected by an authorized KOVEMOTO motorcycle service center.

**Notes**

- Continuing to ride with an overheated engine can cause serious engine damage.
- Running the engine at high speed in neutral for an extended period may trigger a high coolant temperature alarm.

## Puncture

If the tire is punctured or damaged, replace it rather than repair it. The repaired tire does not perform as well as a new one and may rupture while you are riding. Replacing tires requires specialized tools and professional skills. We recommend entrusting such repairs to authorized KOVEMOTO motorcycle service centers.

### **▲Warning**

- Riding a motorcycle with a temporarily patched tire is extremely hazardous. If the patch fails, it could lead to an accident, causing severe injuries or fatalities.
- If you must ride a motorcycle with a temporarily repaired tire, ride cautiously and slowly, not exceeding 50 km/h, until the tire is replaced.

## Removing the Wheel

### Front wheel

If you need to remove the wheel to repair a punctured tire, follow the steps below.

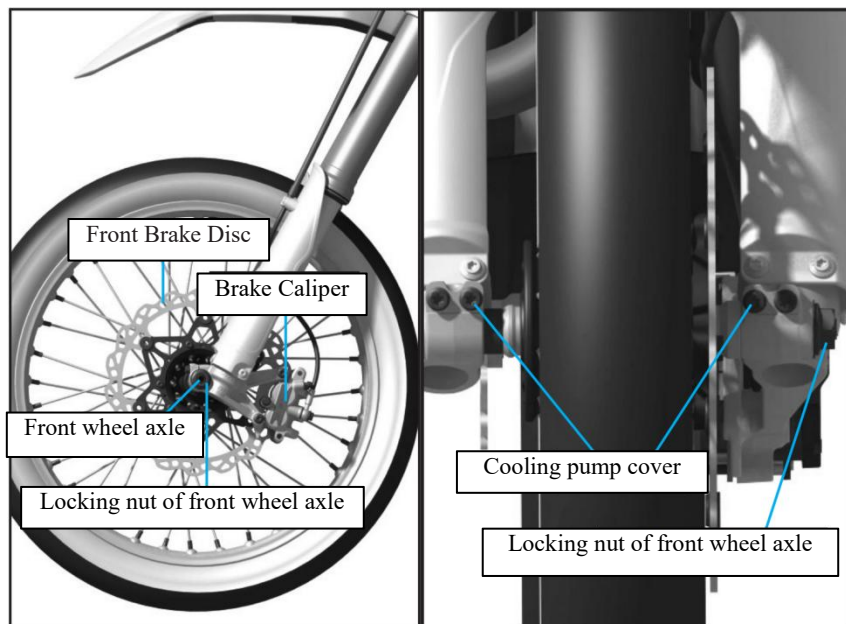

#### Disassemble:

1. Securely support your motorcycle with a maintenance bracket or a crane and lift the front wheels off the ground.
2. Loosen the front axle nut and the left and right axle locking bolts.
3. Extract the front axle from the wheel hub and remove the front wheel.

## Installation

1. Clean the front axle and the mounting holes of the front shock absorber. Apply grease evenly around the groove between the primary and secondary lips of the front hub oil seal.
2. Position the front wheel between the front shock absorbers, ensuring the brake disc is seated in the brake caliper, and take care not to damage the brake pads.
3. Insert the front axle from right to left through the front shock absorber and wheel hub, then tighten the front axle nut and the lock bolts on both sides. (Front axle M16, torque: 88 N·m; front axle locking bolt M8, torque: 22 N·m.)
4. Place the front wheel on the ground.
5. Operate the hand brake lever several times, then shake the front fork up and down several times.
6. Lift the front wheel off the ground again, and after releasing the brake lever, check if the wheel turns smoothly.

If a torque wrench was not used during the installation process, please take it to an authorized KOVEMOTO motorcycle service center as soon as possible. Improper installation may result in reduced braking performance.

## Notes

- When reinstalling the wheel or caliper, carefully position the brake disc between the brake pads to prevent scratching them.
- When installing the front wheel, first tighten the front axle, then secure the lock bolt on the right side of the front axle. The order of these steps cannot be reversed.

## Rear wheel

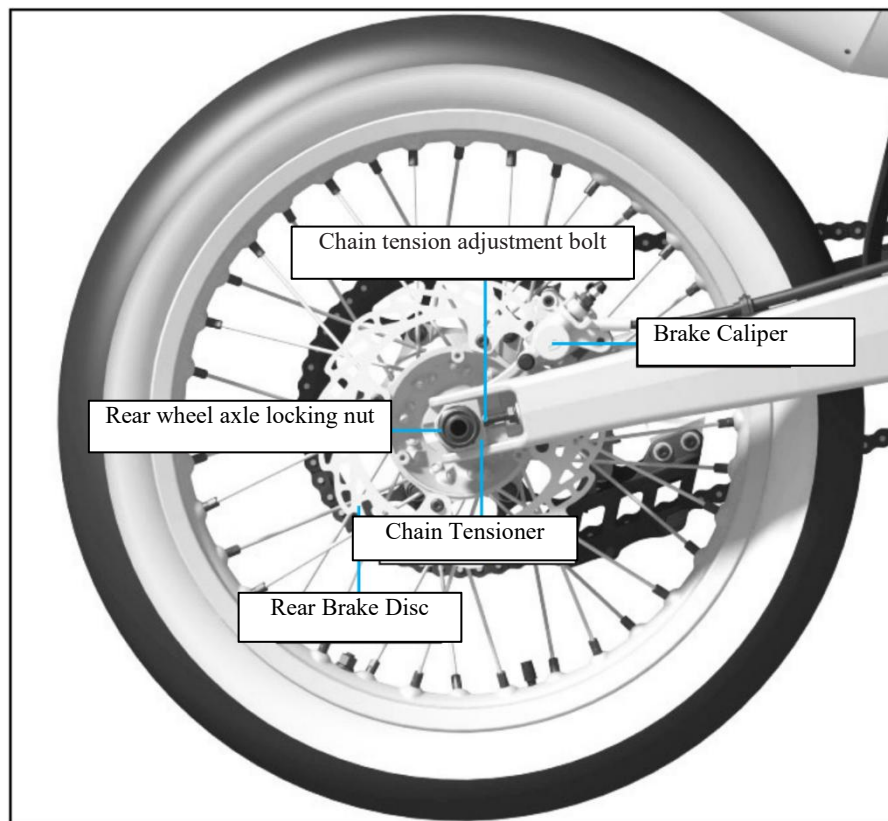

### Disassembly

1. Park the motorcycle on a firm and flat level.
2. Firmly support your motorcycle with side brackets or service bracke and lift the rear wheels off the ground.
3. Remove the rear axle nut.
4. Support the rear wheel and remove the rear axle.
5. Remove the drive chain from the drive sprocket.
6. Remove the rear wheel.
7. Remove the rear brake caliper assembly from the swingarm slot.
  - Support the brake caliper assembly well and do not hang it on the brake hose. Do not twist the brake hose.
  - Avoid getting lubricating oil, engine oil or dirt on the brake disc or brake pad.
  - Do not press the brake pedal when the brake caliper is removed.
  - Be careful to prevent the brake caliper from scratching the wheel during removal.

## Installation

1. Check if the rear wheel bearing is damaged. If the bearing is damaged, replace the rear wheel bearing. Apply grease evenly in the groove between the primary and secondary lips of the oil seal.
2. Clean the rear axle and the rear swingarm mounting holes.
3. Install the rear brake caliper assembly into the rear swingarm slot.
4. Push the rear wheel into the rear swingarm while inserting the brake disc into the brake caliper, taking care not to damage the brake pads.
5. Reinstall the drive chain onto the drive sprocket.
6. Insert the rear axle and rotate the rear wheel to fully engage the drive chain with the drive sprocket.
7. Tighten the rear axle nut, torque: 128 N·m.

If a torque wrench was not used during the installation process, please take it to an authorized KOVEMOTO motorcycle service center as soon as possible. Improper installation may result in reduced braking performance.

## Notes

- When reinstalling the wheel or caliper, carefully position the brake disc between the brake pads to avoid scratches.

## Electrical malfunction

### The battery is dead.

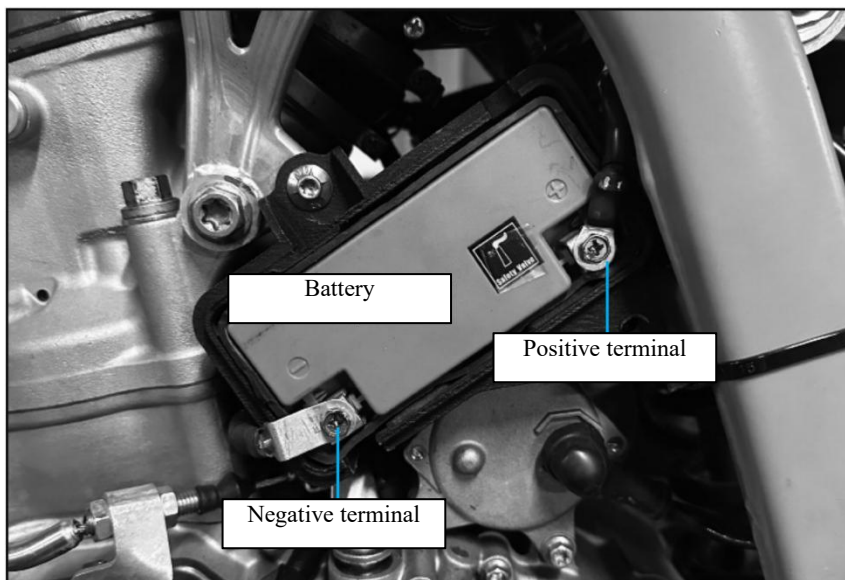

Please charge the battery using a dedicated motorcycle lithium battery charger. Remove the battery from the motorcycle before charging. If the battery does not recover after charging, please contact the authorized KOVEMOTO Motorcycle service center.

### Notes

- Avoid using a car battery charger or a motorcycle lead-acid battery charger for charging, as this may result in battery damage or even a fire.

## Relevant information

Motorcycle Care .....	68
Motorcycle Parking .....	71
Motorcycle Transport .....	71
You and Your Environment .....	72
Vehicle identification number, engine number, and nameplate .....	73
Catalytic Converter .....	74

## Motorcycle Care

Regular cleaning and polishing ensure a long motorcycle lifespan. A clean motorcycle makes it easier to spot potential faults. It is particularly noteworthy that anti-icing seawater and salt scattered on the road can accelerate corrosion. Be sure to clean the motorcycle thoroughly after driving on the coastal or above-mentioned road.

### Cleaning

Wait for the engine, muffler, brakes, and other high-temperature components to cool before cleaning.

1. Thoroughly rinse the motorcycle with a low-pressure hose to remove loose dirt.
2. If necessary, use a sponge or soft towel dipped in mild detergent to remove dust and dirt.
3. Thoroughly rinse the motorcycle with ample clean water and dry it using a clean, soft cloth.
4. After drying the motorcycle, lubricate the moving parts, ensuring that no lubricant splashes onto the brakes or tires. Oil-contaminated brake discs, brake pads, brake drums, or brake shoes can significantly reduce braking performance and may lead to accidents.
5. After washing and drying the motorcycle, lubricate the drive chain promptly.
6. Waxing helps prevent corrosion.

Avoid using products containing strong detergents or chemical solvents, as these substances can damage the motorcycle's metal parts, paint, and plastic components. Do not wax the tires and brakes.

If your motorcycle has parts with a matte finish, avoid waxing these matte surfaces.

## Cleaning Precautions

- Avoid using a high-pressure water jet:
  - ▶ High-pressure water jets can damage moving parts and electrical components, rendering them irreparable.
  - ▶ Moisture from the intake port may be drawn into the throttle body or enter the air filter.
- Avoid direct water rinsing of the muffler:
  - ▶ Water in the muffler may cause starting problems and rust. If detected, remove all traces and dirt immediately.
- Dry the brakes:
  - ▶ Water reduces braking performance. After washing, intermittently use the brakes at low speed, repeatedly pressing the brake pedal lightly to generate heat from friction, drying the water until braking efficiency is restored.
- Avoid direct water contact beneath the seat cushion:
  - ▶ Water entering under the seat cushion may damage electrical appliance parts.
- Avoid rinsing the air filter directly with water.
  - ▶ If the air filter gets wet, the engine may fail to start.
- Avoid direct water contact near the headlight:
  - ▶ After washing or riding in the rain, the internal lens of the headlight may temporarily fog up, but this does not affect its functionality. However, if you notice a significant accumulation of water or ice inside the lens, have it inspected by an authorized KOVEMOTO Motorcycle service center.
- Avoid waxing or polishing matte finishes:
  - ▶ Use sufficient water and a mild cleanser to clean matte paint surfaces, and dry them with a clean, soft cloth.

### Aluminum Components

Aluminum corrodes when exposed to dirt, mud, or salt. Regularly clean aluminum components and follow these guidelines to prevent scratches:

- Avoid using stiff brushes, steel wool, or any abrasive cleaning materials.
- Do not drive or scrape against the curb.

### Panel

Follow these guidelines to prevent scratches and damage:

- Gently clean with a sponge and sufficient water.
- Clean with diluted detergent and rinse thoroughly with ample water to remove stubborn stains.
- Avoid exposing the instrument panel and lamp covers to corrosive liquids like gasoline and brake fluid.

## Motorcycle Parking

If you leave your motorcycle outdoors, you should consider using a full motorcycle cover. If you do not ride for an extended period of time, please follow these guidelines:

- Wash the motorcycle and wax all painted surfaces (excluding matte finishes), then apply anti-rust oil to all chrome parts.
- Lubricate the drive chain.
- Place the motorcycle on a maintenance stand and elevate it with wooden blocks to ensure both tires are off the ground.
- After rain, remove the body cover and dry it in a ventilated place.
- Remove the battery to avoid discharging.

Fully charge the battery and store it in a cool, well-ventilated area. If you leave the battery in place, disconnect the negative terminal to prevent discharge. Before reusing a stored motorcycle, inspect all items as specified in the maintenance interval table.

## Motorcycle Transport

If you need to transport your motorcycle, use a motorcycle trailer, loading ramp, or flatbed truck equipped with a lifting platform, and secure it with motorcycle tie-down straps. Never attempt to tow a motorcycle with its wheels on the ground.

### Notes

- Towing a motorcycle can severely damage the drivetrain.

## You and Your Environment

Owning and riding a motorcycle is an enjoyable experience, but you must take responsibility for protecting the environment.

### Select the appropriate detergent

Use biodegradable detergents when washing your motorcycle, and avoid sprays containing chlorofluorocarbons (CFCs) as they harm the protective ozone layer in the atmosphere.

## Waste Recycling

Sort the oil and other toxic wastes into approved containers and send them to the recycling center. Call the local national public affairs or environmental service office for the recycling center in your area and the disposal method of non-recyclable wastes. Do not pour used engine oil into trash cans, sewers or ground, because the used oil, gasoline, coolant and cleaning solvent contain toxic substances, which will hurt cleaners, pollute drinking water, lakes, rivers and seas.

## Vehicle identification number, engine number, and nameplate

When registering a motorcycle, you must provide the vehicle identification number and engine number. These unique identifiers are used to distinguish your motorcycle. When ordering replacement parts, ensure you record these numbers and store them in a secure location.

### Vehicle Identification Number (VIN)

The VIN is engraved on the left side of the frame head beam

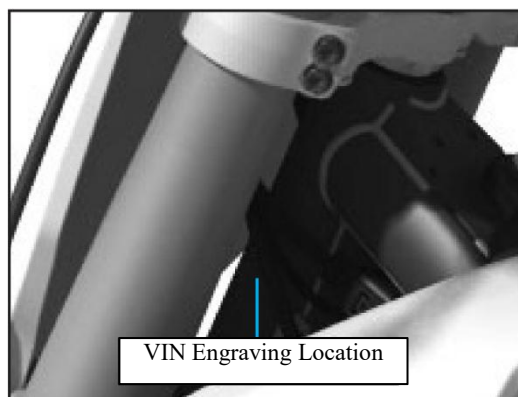

### Engine Number

The engine number is engraved on the left side of the crankcase.

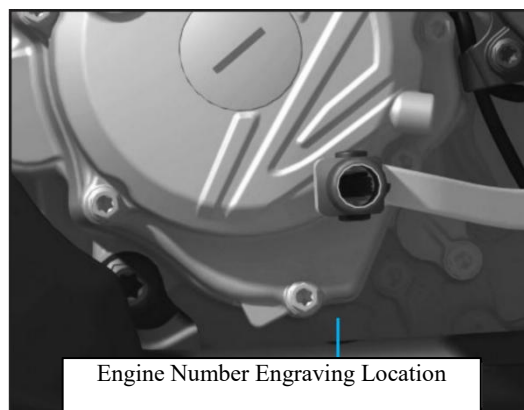

### Nameplate

The nameplate is affixed to the lower edge of the left side of the frame.

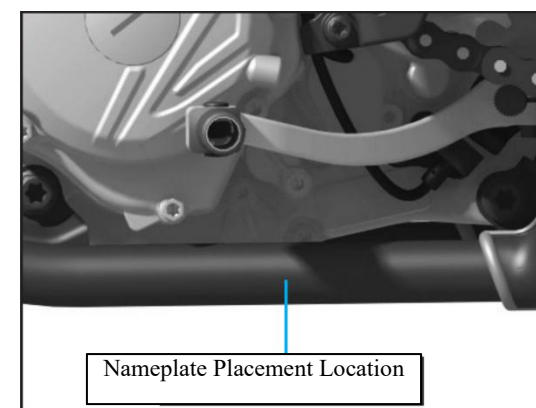

## Catalytic Converter

This motorcycle is equipped with a three-way catalytic converter. The catalytic converter contains precious metals as catalysts for high-temperature chemical reactions, transforming hydrocarbons (HC), carbon monoxide (CO), and nitrogen oxides (NO<sub>x</sub>) in the exhaust into compliant mixtures.

A faulty catalytic converter can pollute the air and reduce your engine's performance. When replacing it, always use genuine Buick motorcycle parts.

Follow these guidelines to safeguard your motorcycle's catalytic converter:

- Only unleaded gasoline should be used, as leaded gasoline can damage the catalytic converter.
- Maintain the engine in optimal operating condition.
- If the engine fails to start, backfires, stalls, or exhibits other poor performance, stop riding immediately and turn off the engine. Have the motorcycle inspected by an authorized KOVEMOTO motorcycle service center.

## Technical Parameters

Vehicle-Related Parameters .....	76
Torque Parameters .....	78
Frame Tightening Torque .....	79

**Vehicle-Related Parameters -1**

Vehicle Model	MX250	Engine Model	Z179MM
Total length (mm)	2168	Bore (mm) × Stroke (mm)	79×51
Total width (mm)	805	Compression ratio	13.9:1
Total height (mm)	1265	Maximum power (kW/r/min)	30/12000
Wheelbase (mm)	1490	Maximum torque (N·m/rpm)	27/9500
Wheelbase (mm)	/	Idle speed (rpm)	2200
Curb weight	101	Cylinder capacity (mL)	249.9
Payload (kg)	75	Spark plug	TORCH-BN9RSI
Front tire specifications	80/100-21	Spark plug gap (mm)	1±0.05
Rear tire specifications	100/90-19	Valve clearance (mm)	0.1±0.02
Maximum speed (km/h)	129		0.2±0.02

**Vehicle-Related Parameters - 2**

Lubricating oil capacity (L)	1.35	Main fuse	20A
Fuel capacity (L)	6.5		
Primary transmission ratio	3.473		
First gear	2.230		
Second gear	1.75		
Third gear	1.47		
Fourth gear	1.227		
Fifth gear	1.043		
Final transmission ratio	3.846		
Battery	12V 2.3Ah (Lithium-ion Battery)		
Ignition mode	ECU controls ignition		

### Torque Parameters

Fastener Type	Torque	Fastener Type	Torque
5mm bolt and nut	6	6mm Screw	8
6mm bolt and nut	12	6mm flange bolt (8mm head, small flange)	10
8mm bolt and nut	22	6mm flange bolt (8mm head, large flange)	12
10mm bolt and nut	60	6mm flange bolt (10mm head) and nuts	12
12mm bolt and nut	80	8mm Flange Bolt and Nut	22
5mm Screw	5	/	/

#### Notes

- Except for the specified torque, the standard torque values in the above table apply to this vehicle

### Frame Tightening Torque

Item	Thread Diameter (mm)	Torque (N·m)	Notes
Self-Tapping Screw Connecting the Rear Fender to the Rear Housing of the Air Filter Tank	ST4.8	2	
Philips Half-round Head Screw for Connecting the Handlebar Grip to the Handlebar Tube	M4	7	
Hexalobular Pan Head Screw for Left/Right Handle Switch Connection	M4	3	
Hexalobular Pan Head Screw Connecting the Mid-Section of the Fuel Tank (Seat Limit Bushing Mounting Point)	M5	5	
Hexalobular Pan Head Screw Connecting the Fuel Pump to the Fuel Tank	M5	4	
Hexalobular Pan Head Screw Connecting the Front Section of Muffler	M5	5	
Hexalobular Pan Head Step Screw Connecting the Right Mounting Point of the Air Filter to the Rear Rack	M5	5	
Hexalobular Pan Head Step Screw Connecting the Left Mounting Point of the Air Filter to the Rear Rack	M5	5	
Hexagon Flange Bolt Connecting Chain Guide and Wear Blocks	M5	5	
Hex Lock Nut for Chain Guide Assembly Connection	M5	5	
Philips Pan Head Screw Connecting the Oil Pipe Clamp to the Swingarm	M5	5	
Rear Brake Pedal Hexagon Flange Bolt (Brake Rocker Arm)	M5	8	Apply Adhesive to the Threads
Philips Pan Head Screw for Securing the Wiring at the Rear of the Fuel Tank	M5	5	
Hexalobular Hex Flange Bolt for Quick Shift Sensor Connection	M5	6	
Hexalobular Pan Head Step Screw Connecting the Number Plate to the Upper Triple Clamp	M5	5	
Hexalobular Pan Head Step Screw Connecting the Engine Lower Protector to the Frame	M5	5	
Hexalobular Pan Head Step Screw for Left/Right Connection of Fuel Tank Front Trims	M5	5	

Item	Thread Diameter (mm)	Torque (N·m)	Notes
Hexalobular Pan Head Screw Connecting the Front Brake Oil Pipe Pressure Plate and the Left Front Shock Absorber Trim Piece	M5	1	
Hexalobular Pan Head Step Screw Connecting the Battery Box Cover to the Battery Box	M5	5	
Hexagon Flange Bolt for Battery Box Installation and Connection	M5	5	
Philips Pan Head Screw for Connecting the Left/Right Frame Trims to the Frame	M5	5	
Hexalobular Flange Bolt Connecting the Radiator and Radiator Grille	M5	5	
Hexalobular Pan Head Step Screw Connecting the Tailpipe Plug to the Subframe	M6	5	
Hexalobular Flange Bolt Connecting the Fuel Tank Rear to the Frame	M6	10	
Hexalobular Pan Head Screw Connecting the Fuel Tank Front to the Frame	M6	10	
Hexalobular Pan Head Step Screw Connecting the Wire Harness Clamp Left/Right to the Frame	M6	6~8	
Hexagon Flange Bolt for Left/Right Radiator Connection	M6	10	
Hexalobular Cylindrical Head Screw Connecting the Injector cap to the Throttle Body	M6	8	
Shift Arm Pinch Hexagon Flange Bolt	M6	10	
Front Disc Brake Hexagon Flange Bolt (Front Hub)	M6	12	Apply Adhesive to the Threads
Hexalobular Pan Head Connecting the Front Brake Hose Clip to the Lower Connecting Plate	M6	10	
Rear Disc Brake Hexagon Flange Bolt (Rear Hub)	M6	12	
Chain Clip Philips Half-round Head (Swingarm)	M6	8	Apply Adhesive to the Threads
Hexalobular flange bolt connecting the chain guide to the swingarm	M6	10	
Hexagon Flange Bolt for Chain Guide Adhesive Installation and Connection	M6	10	

Item	Thread Diameter (mm)	Torque (N·m)	Notes
Hexagon Flange Bolt Connecting the Clutch Lever to the Mounting Base	M6	8	
Hexalobular Pan Head Screw Connecting the Frame to the Rear Brake Pump	M6	12	Apply Adhesive to the Threads
Hexagon Flange Bolt Connecting the Voltage Regulator and the Air Filter Box Housing	M6	10	
Hexagon Flange Bolt Connecting the Ignition Coil Clamp and the Engine	M6	10	
Front Fender Hexagon Flange Bolt (Lower Connecting Plate)	M6	12	
Front Rear Fender Hexagon Screw (Subframe)	M6	8	
Hexagon Flange Bolt Connecting the Small Sprocket Cover and the Engine	M6	10	
Frame (Left/Right) Hexagon Screw (Subframe)	M6	8	
Frame (Left/Right) Hexagon Screw (Subframe)	M6	8	
Hexalobular Pan Head Step Screw Connecting the Front Trims (Left/Right) to the Front Shock Absorber Bottom Cylinder	M6	8	
Hexalobular Pan Head Screw Connecting the Rear Cover to the Seat Cushion	M6	8	
Hexalobular Flange Bolt Connecting the Front Brake Pump to the Handlebar Tube	M6	12	
Hexalobular Flange Bolt Connecting the Upper Handlebar Clamp to the Lower Handlebar Bracket 4 - Factory Team Edition	M7	15	
Hexalobular Flange Bolt Connecting the Upper Connecting Plate to the Front Shock Absorber 4 - Factory Team Edition	M7	15	
Hexalobular Flange Bolt Connecting the Lower Connecting Plate to the Front Shock Absorber 4 - Factory Team Edition	M7	15	
Hex Flange Bolt Connecting the Subframe to the Chassis	M8	34	Apply Adhesive to the Threads

Item	Thread Diameter (mm)	Torque (N·m)	Notes
Engine Mounting Hexagon Flange Screw (Front)	M8	26	
Engine Mounting Hexagon Flange Screw (Upper)	M8	36	
Hexalobular Flange Bolt Connecting the Guide Sprocket to the Subframe	M8	22	
Muffler Front Section Hexagon Flange Nut (Exhaust Port)	M8	16	
Muffler Rear Section Hexagon Flange Bolt (Subframe)	M8	22	
Hexalobular Flange Bolt for Securing the Connection of the Front Shock Absorber Bottom Cylinder (Left/Right)	M8	22	
Hexalobular Flange Bolt Connecting the Upper Connecting Plate to the Front Shock Absorber (Locked)	M8	22	
Hexalobular Flange Bolt Connecting the Lower Connecting Plate to the Front Shock Absorber (Locked)	M8	22	
Hexalobular Flange Bolt Connecting the Left Front Shock Absorber to the Front Brake Caliper	M8	32	Apply Adhesive to the Threads
Large sprocket hexagon screw (Rear Hub)	M8	38	Apply Adhesive to the Threads
Hex Bolt for Adjusting and Connecting Left and Right Chains	M8	10	
Hex Flange Nut for Swingarm Assembly Connection	M8	8	
Hex Cylinder Cylindrical Head Screw Connecting the Handlebar to the Upper and Lower Mounts	M8	22	
Hexagon Flange Self-locking Nut Connecting Handlebar	M8	22	
Bolt Connecting the Rear Brake Rocker Arm to the Frame	M8	22	Apply Adhesive to the Threads
Hexagonal Flange Self-locking Nut Connecting the Engine Front Suspension to the Connecting Plate	M10	54	
Hex Flange Self-locking Nut Connecting the Engine Lower to the Frame	M10	60	
Hexalobular Flange Bolt Connecting the Engine Lower to the Frame	M10	54~60	
Flat-head Bolt Connecting the Rear Shock Absorber to the Triangular Swingarm	M10	44	

Item	Thread Diameter (mm)	Torque (N·m)	Notes
Engine Mounting Hexagon Flange Screw (Front and Mid Mounting Point)	M10	54~60	
Engine Upper Mounting Hexagon Flange Screw (Left/Right) Connecting the Engine	M10	54	
U-shaped Swingarm Assembly Connecting Hexagon Flange Bolt	M10	60	
U-shaped Swingarm Assembly Connecting Hex Flange Self-locing Nut	M10	60	
Rear Shock Absorber Hexagon Flange Nut (Triangular Cradle)	M10	44	
Hexalobular Flange Bolt Connecting the Frame to the Rear Shock Absorber	M10	44	
Oil Passage Bolt Connecting the Brake Hose to the Rear Brake Caliper	M10	22	
Oil Passage Bolt Connecting the Brake Hose to the Rear Brake Pump	M10	22	
Oil Passage Bolt Connecting the Front Brake Hose to the Front Brake Caliper	M10	22	
Flat-head Bolt Connecting the U-shaped Cradle to the Triangular Cradle	M12	60	
Flat-head Bolt Connecting the Swingarm to the Triangular Cradle	M12	60	
Hex Flange Self-locking Nut Connecting the Swingarm to the U-shaped cradle	M12	60	
Front Wheel Axle Locking Nut	M16	88	
Plain fork axle locking nut	M16	88	
Rear Wheel Axle Locking Nut	M22	128	
Hex Nut Connecting the Steering Column to the Upper Connecting Plate	M24	108	Apply lubricant to the gasket
8-slot Adjusting Nut Connecting the Steering Column	M25	First stage: 40N·m, second stage: loosen the adjusting nut by two turns and then tighten it to 10N·m, third stage: keep the direction fixed and loosen by 1/4 turn	